

Please make sure that you print this resource at 100% so that all measurements are correct.

To do this, follow the relevant steps below.

Adobe Reader or Adobe Acrobat

- Adobe Reader is a free PDF viewer, from Adobe. To install a copy of Adobe Reader, go to <https://get.adobe.com/uk/reader/>.
- Once Adobe Reader is installed, open your PDF.
- Go to File>Print.
- Under 'Page Sizing & Handling', select 'Size'.
- From here, make sure that 'Actual Size' is selected.
- Print this page as a test, making sure that the shape below is the correct size once printed.
- If the test print is correct, print your PDF.

Foxit Reader

- Go to File>Print.
- Set the 'Scaling' to 'None'.
- Print this page as a test, making sure that the shape below is the correct size once printed.
- If the test print is correct, print your PDF.

Web Browser

- If printing from a web browser, such as Chrome, Firefox or Microsoft Edge make sure that your printer is set to print at 100%, either by unticking 'Fit to Page' or selecting 'Actual Size'.
- Print this page as a test, making sure that the shape below is the correct size once printed.
- If the test print is correct, print your PDF.

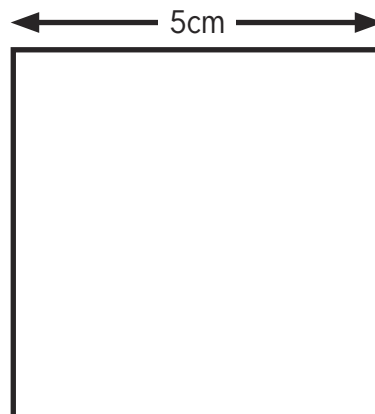

Maths Revision



Number and Place Value

Counting

Count forwards and backwards in 4, 6, 7, 8, 9, 25, 50, steps of powers of 10 (10, 100, 1000, ...)

1. Continue the sequences:

7, 14, 21, 28, 35, 42, _____, _____, _____, _____, _____,

625, 600, 575, 550, 525, _____, _____, _____, _____, _____,

57 382, 67 382, 77 382, 87 382, _____, _____, _____, _____, _____,

2. Find 10, 100 or 1000 more or less than a given number

What is 100 less than 1902? What is 1000 more than 3249?

3. Count forwards and backwards through zero

Continue the sequence:

6, 5, 4, 3, 2, 1, 0, -1, -2, -3 _____, _____, _____, _____, _____.

Place Value

Recognise the place value of each digit in up to four-digit numbers

hundred thousands ten thousands thousands hundreds tens ones

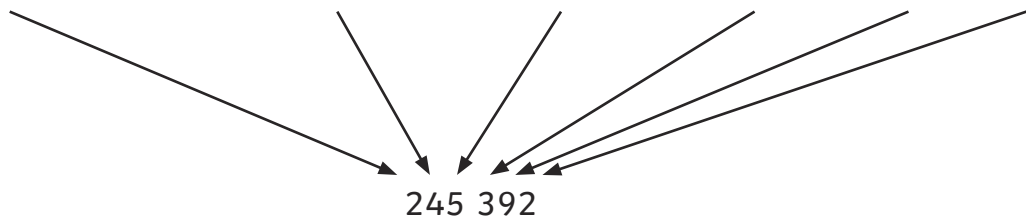

4. Underline the thousands digit in 2769.

Underline the hundred thousands digit in 347 053.

Underline the tens digit in 209 740.

Compare and Order Numbers

Compare using $<$, $>$ or $=$

5. Write a number so that each sentence makes sense:

$$141\ 141 > \underline{\hspace{2cm}}$$

$$144\ 114 = \underline{\hspace{2cm}}$$

$$501\ 243 < \underline{\hspace{2cm}}$$

6. Order the following numbers from largest to smallest:

Smallest 121 211 11 112 122 211 11 211 121 211 Greatest

Identify, Represent and Estimate

Use models and representations of numbers

7. What number is shown? _____

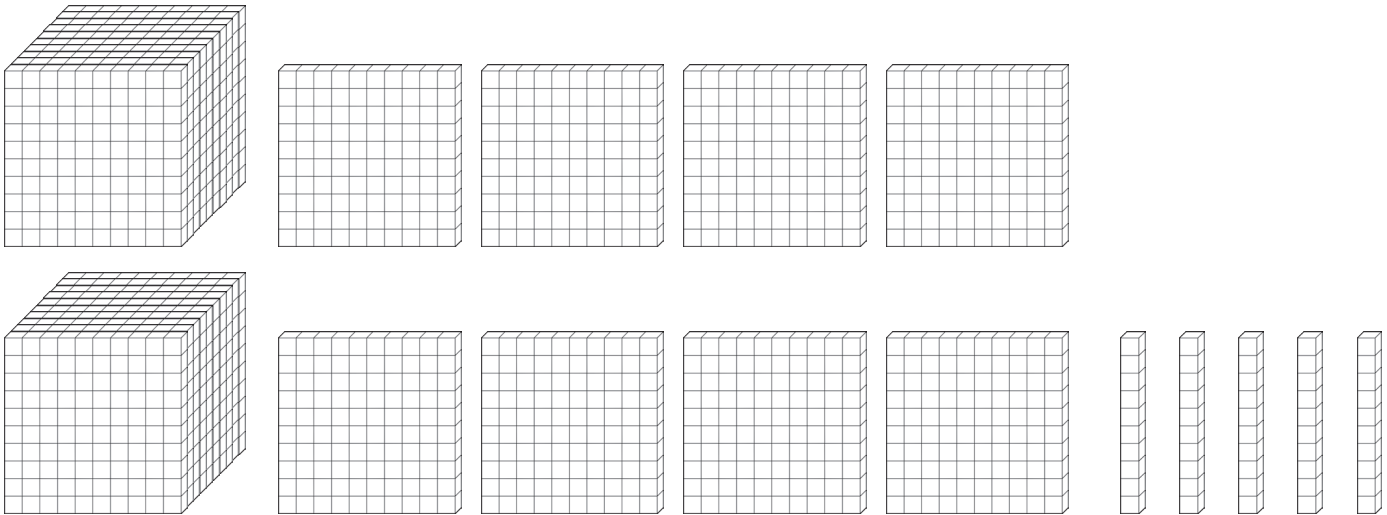

Rounding

Round numbers to the nearest 10, 100, 1000, 10 000 or 100 000

8. 4500 rounded to the nearest 1000 is _____

253 450 to the nearest 10 000 is _____

Read and Write Numbers in Numerals and Words

9. Complete the table:

| Numerals | Words |
|----------|--|
| | Three hundred and forty-four thousand, two hundred and eighty-five |
| 855 102 | |
| | Six hundred and twenty-two thousand, nine hundred and sixteen |
| 120 563 | |

Roman Numerals

10. Use the following Roman numerals to represent numbers to 100:

| Roman | Numeral |
|-------|---------|
| I | 1 |
| V | 5 |
| X | 10 |
| L | 50 |
| C | 100 |
| D | 500 |
| M | 1000 |

CCXIX = _____

DCXXVI = _____

CMXLVIII = _____

MDCCCLXXI = _____

Solve Problems

11. Here are 3 years written in Roman Numerals. Order the years from earliest to latest:

MMIX

MCMXCIX

MMXV

Addition and Subtraction

Add and Subtract Mentally

12. Add and subtract three-digit numbers and ones, tens and hundreds

$376 + 3 = \underline{\hspace{2cm}}$

$376 + 40 = \underline{\hspace{2cm}}$

$376 + 200 = \underline{\hspace{2cm}}$

Mental Methods

13. Add and subtract numbers mentally with larger numbers

$15\,672 - 3200 = \underline{\hspace{2cm}}$

Formal Methods

14. Use a formal written method to calculate:

$$\begin{array}{r} 7\ 2\ 6\ 9\ 8 \\ +\ 6\ 1\ 5\ 6\ 2 \\ \hline \\ \hline \end{array}$$

$$\begin{array}{r} 8\ 4\ 9\ 3\ 5 \\ -\ 1\ 2\ 4\ 2\ 3 \\ \hline \\ \hline \end{array}$$

$$\begin{array}{r} 6\ 4\ 8\ 1\ 2 \\ -\ 2\ 9\ 3\ 6\ 4 \\ \hline \\ \hline \end{array}$$

Estimate and Inverse

15. Estimate by rounding to check accuracy.

Use the inverse to check the following calculations. Circle 'correct' or 'incorrect.'

$$6470 + 1248 = 7718$$

correct/incorrect

$$5905 - 2674 = 2231$$

correct/incorrect

Solve Problems

Multi-step problems

16. 8451 people visit a cinema on one day. There are two films showing. 3549 adults and 946 children see an adventure film, 1263 adults and a number of children see an animation.

How many adults are there? _____

How many children are there? _____

How many children see the animation? _____

How many more children see the animation than the adventure film? _____

Multiplication and Division

Multiplication Tables

17. Fill in the missing numbers:

| × | 1 | 2 | 3 | 4 | 5 | 6 | 7 | 8 | 9 | 10 | 11 | 12 |
|----|----|----|----|----|----|----|----|----|----|----|-----|-----|
| 1 | 1 | | 3 | | 5 | 6 | | 8 | | 10 | 11 | |
| 2 | | 4 | | 8 | 10 | | 14 | | 18 | | | 24 |
| 3 | 3 | | 9 | | | | | | | 30 | | 36 |
| 4 | | | | | 20 | | | | | | 44 | |
| 5 | | | | | | 30 | | | | | 55 | |
| 6 | 6 | | | | | 36 | | 48 | | 60 | | 72 |
| 7 | 7 | | 21 | | 35 | | 49 | | 63 | | 77 | |
| 8 | | | | 32 | | | 56 | | 72 | | 88 | 96 |
| 9 | 9 | 18 | | | 45 | | | 72 | | 90 | | 108 |
| 10 | 10 | | 30 | | | 60 | | | | | | 120 |
| 11 | | | 33 | | 55 | | | | | | 121 | |
| 12 | 12 | | 36 | | | 72 | | | | | | 144 |

Multiplying and Dividing

18. Use knowledge of place value and related facts to solve these calculations:

$400 \times 5 = \underline{\hspace{2cm}}$

$630 \div 7 = \underline{\hspace{2cm}}$

Multiply by 0 and 1 and divide by 1:

$285 \times 1 = \underline{\hspace{2cm}}$

$285 \times 0 = \underline{\hspace{2cm}}$

$285 \div 1 = \underline{\hspace{2cm}}$

Multiplying and dividing whole numbers and decimals by 10, 100 and 1000:

$45 \times 10 = \underline{\hspace{2cm}}$

$6.7 \times 100 = \underline{\hspace{2cm}}$

$902 \times 1000 = \underline{\hspace{2cm}}$

$59 \div 10 = \underline{\hspace{2cm}}$

$4506 \div 100 = \underline{\hspace{2cm}}$

$382 \div 1000 = \underline{\hspace{2cm}}$

Factor Pairs and Commutativity

19. What are all the factor pairs of 56? _____

Use your factor pairs to solve:

56 pencils are shared between 4 tables. How many pencils does each table receive?

20. Change the order of the numbers in these calculation without changing the answer:

$5 \times 9 \times 2 = 90$ _____

$6 \times 3 \times 10 = 180$ _____

Prime Numbers

21. List all the prime numbers up to 20. _____

List all prime numbers between 20 and 30. _____

What would be the first prime number after 100? _____

Square and Cube Numbers

22. Write these numbers into the correct place in the table:

9, 144, 27, 4, 1, 8, 100, 81, 125, 16, 25, 64, 121

| Square Numbers | Cube Numbers |
|----------------|--------------|
| | |

Formal Methods

23. Use formal written methods to multiply:

| | | | | |
|-------|---|---|---|---|
| | | | 2 | 7 |
| <hr/> | | | | |
| | | x | | 4 |
| <hr/> | | | | |
| | | | | |
| <hr/> | | | | |
| | | 3 | 8 | 2 |
| <hr/> | | | | |
| | x | | | 7 |
| <hr/> | | | | |
| | | | | |
| <hr/> | | | | |
| | 2 | 4 | 7 | 1 |
| <hr/> | | | | |
| x | | | | 6 |
| <hr/> | | | | |
| | | | | |
| <hr/> | | | | |
| | | | | |

24. a) Use the formal long multiplication method to calculate:

| | | | | |
|-------|--|---|---|---|
| | | | 2 | 7 |
| <hr/> | | | | |
| | | x | 1 | 4 |
| <hr/> | | | | |
| | | | | |
| <hr/> | | | | |
| | | | | |
| <hr/> | | | | |
| | | | | |

b) Use a short division method to solve these problems:

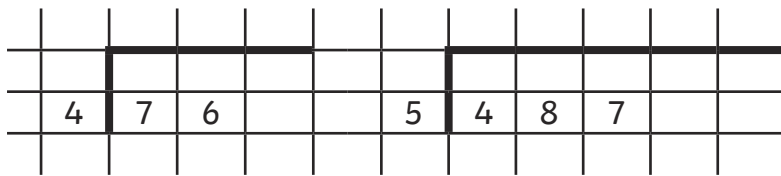

25. Fill in the missing numbers to complete the calculations.

$\times 3 = 45$ or $56 \div$ $= 14$

Word Problems:

26. A teacher has four new boxes of pencils, each with 12 pencils, and a tray with 37 pencils. The teacher shares equally all the pencils between 5 tables. How many pencils does each table receive? Show your working out below.

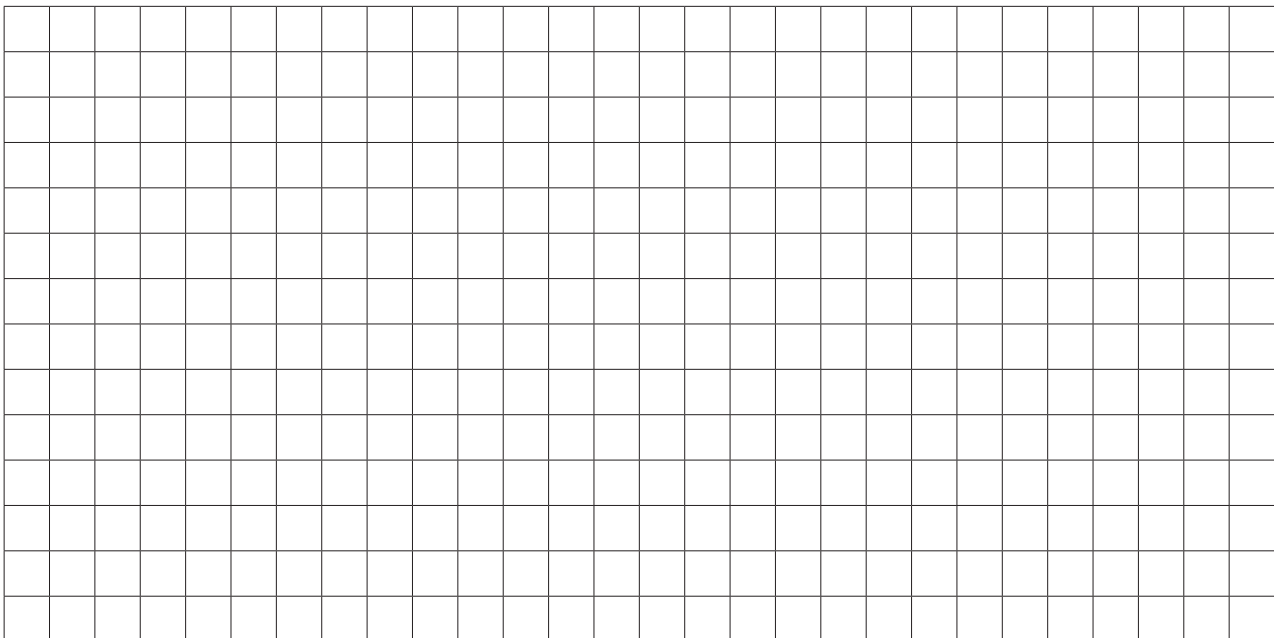

Scaling Problems with Simple Fractions

27. 12 pizzas are cut into quarters. Into how many pieces of pizza will the pizzas be cut?

Correspondence problems

28. Jenna has 2 t-shirts and 4 pairs of shorts. How many different combinations of the t-shirts and shorts does Jenna have? _____

29. 120 pencils are shared equally between 3 classes. How many pencils will they each receive?

Fractions

30. Shade to show $\frac{7}{10}$:



Shade to show $\frac{46}{100}$:

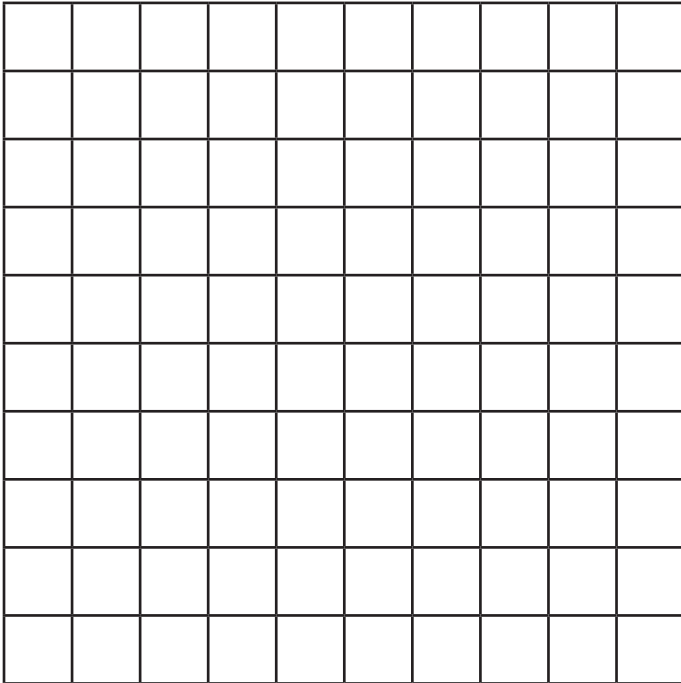

Fraction of a Set of Marbles

31. Find $\frac{5}{8}$ of these marbles by circling:

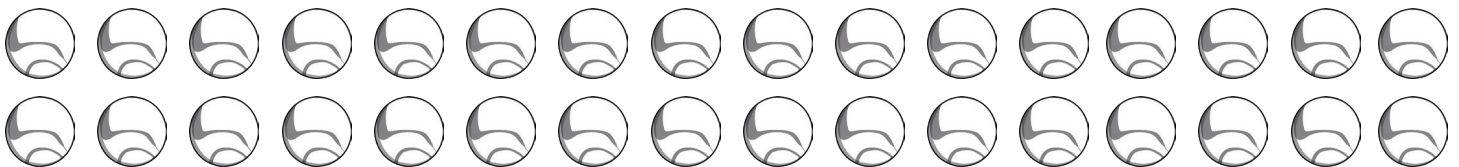

Equivalent Fractions

32. Write in the missing fractions



| | | | | | | | | | | | | | | | |
|----------------|----------------|----------------|----------------|----------------|----------------|----------------|----------------|----------------|----------------|----------------|----------------|----------------|----------------|----------------|----------------|
| 1 | | | | | | | | | | | | | | | |
| $\frac{1}{2}$ | | | | | | | | $\frac{1}{2}$ | | | | | | | |
| $\frac{1}{4}$ | | | | $\frac{1}{4}$ | | | | $\frac{1}{4}$ | | | | $\frac{1}{4}$ | | | |
| $\frac{1}{16}$ | $\frac{1}{16}$ | $\frac{1}{16}$ | $\frac{1}{16}$ | $\frac{1}{16}$ | $\frac{1}{16}$ | $\frac{1}{16}$ | $\frac{1}{16}$ | $\frac{1}{16}$ | $\frac{1}{16}$ | $\frac{1}{16}$ | $\frac{1}{16}$ | $\frac{1}{16}$ | $\frac{1}{16}$ | $\frac{1}{16}$ | $\frac{1}{16}$ |

| | | | | | | | | | | | | | | | | | | | | | | | | |
|----------------|----------------|----------------|----------------|----------------|----------------|----------------|----------------|----------------|----------------|----------------|----------------|----------------|----------------|----------------|----------------|----------------|----------------|----------------|----------------|----------------|----------------|----------------|----------------|----------------|
| 1 | | | | | | | | | | | | | | | | | | | | | | | | |
| $\frac{1}{3}$ | | | | | | | | $\frac{1}{3}$ | | | | | | | | $\frac{1}{3}$ | | | | | | | | |
| $\frac{1}{6}$ | | | | $\frac{1}{6}$ | | | | $\frac{1}{6}$ | | | | $\frac{1}{6}$ | | | | $\frac{1}{6}$ | | | | $\frac{1}{6}$ | | | | |
| $\frac{1}{12}$ | $\frac{1}{12}$ | $\frac{1}{12}$ | $\frac{1}{12}$ | $\frac{1}{12}$ | $\frac{1}{12}$ | $\frac{1}{12}$ | $\frac{1}{12}$ | $\frac{1}{12}$ | $\frac{1}{12}$ | $\frac{1}{12}$ | $\frac{1}{12}$ | $\frac{1}{12}$ | $\frac{1}{12}$ | $\frac{1}{12}$ | $\frac{1}{12}$ | $\frac{1}{12}$ | $\frac{1}{12}$ | $\frac{1}{12}$ | $\frac{1}{12}$ | $\frac{1}{12}$ | $\frac{1}{12}$ | $\frac{1}{12}$ | $\frac{1}{12}$ | |
| $\frac{1}{24}$ | $\frac{1}{24}$ | $\frac{1}{24}$ | $\frac{1}{24}$ | $\frac{1}{24}$ | $\frac{1}{24}$ | $\frac{1}{24}$ | $\frac{1}{24}$ | $\frac{1}{24}$ | $\frac{1}{24}$ | $\frac{1}{24}$ | $\frac{1}{24}$ | $\frac{1}{24}$ | $\frac{1}{24}$ | $\frac{1}{24}$ | $\frac{1}{24}$ | $\frac{1}{24}$ | $\frac{1}{24}$ | $\frac{1}{24}$ | $\frac{1}{24}$ | $\frac{1}{24}$ | $\frac{1}{24}$ | $\frac{1}{24}$ | $\frac{1}{24}$ | $\frac{1}{24}$ |

| | | | | | | | | | | | | | | | | | | | |
|----------------|----------------|----------------|----------------|----------------|----------------|----------------|----------------|----------------|----------------|----------------|----------------|----------------|----------------|----------------|----------------|----------------|----------------|----------------|----------------|
| 1 | | | | | | | | | | | | | | | | | | | |
| $\frac{1}{5}$ | | | | | $\frac{1}{5}$ | | | | | $\frac{1}{5}$ | | | | | $\frac{1}{5}$ | | | | |
| $\frac{1}{10}$ | | $\frac{1}{10}$ | | $\frac{1}{10}$ | | $\frac{1}{10}$ | | $\frac{1}{10}$ | | $\frac{1}{10}$ | | $\frac{1}{10}$ | | $\frac{1}{10}$ | | $\frac{1}{10}$ | | $\frac{1}{10}$ | |
| $\frac{1}{20}$ | $\frac{1}{20}$ | $\frac{1}{20}$ | $\frac{1}{20}$ | $\frac{1}{20}$ | $\frac{1}{20}$ | $\frac{1}{20}$ | $\frac{1}{20}$ | $\frac{1}{20}$ | $\frac{1}{20}$ | $\frac{1}{20}$ | $\frac{1}{20}$ | $\frac{1}{20}$ | $\frac{1}{20}$ | $\frac{1}{20}$ | $\frac{1}{20}$ | $\frac{1}{20}$ | $\frac{1}{20}$ | $\frac{1}{20}$ | $\frac{1}{20}$ |

33. Write 3 fractions that are equivalent to $\frac{1}{3}$ _____, _____, _____

Add and Subtract Fractions with the Same Denominator and with Denominators that are Multiples

34. Find the missing equivalent fractions.

$$\frac{1}{8} + \frac{3}{8} = \frac{4}{8} =$$



$$\frac{5}{8} - \frac{3}{8} = \frac{2}{8} =$$

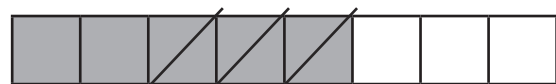

Compare and Order

Unit fractions

35. a) Order these fractions from smallest to greatest:

smallest $\frac{1}{6}$ $\frac{1}{3}$ $\frac{1}{8}$ $\frac{1}{4}$ greatest

b) Use $<$, $>$ or $=$ to compare these fractions:

$$\frac{1}{5} \quad \square \quad \frac{3}{5}$$

$$\frac{5}{8} \quad \square \quad \frac{1}{4}$$

Mixed Numbers and Improper Fractions

36. Write the improper fraction:

Mixed fraction $1\frac{1}{5} =$ - Improper fraction

Multiply Fractions

37. Complete the missing fractions:

$$\frac{2}{3} \times 5 = \frac{\square}{3} = 3 \frac{\square}{3}$$

Decimal Equivalents

38. Complete the missing tenths, hundredths and decimals:

$$\frac{\quad}{10} = 0.7$$

$$\frac{\quad}{100} = 0.43$$

$$\frac{1}{4} = 0.2__$$

$$\frac{1}{2} = 0.__$$

$$\frac{3}{4} = 0.7__$$

Write decimals as a fraction:

$$0.____ = \frac{67}{100}$$

Division by 10 and 100

39.

$$2 \div 10 = \underline{\hspace{2cm}} \quad 2 \div 100 = \underline{\hspace{2cm}} \quad 25 \div 10 = \underline{\hspace{2cm}} \quad 25 \div 100 = \underline{\hspace{2cm}}$$

Rounding Decimals

40. Round these decimals to the nearest whole number:

0.5 rounds to

2.35 rounds to

Round this decimal to one decimal place:

0.05 rounds to

Read, Write, Order and Compare Decimals

41. Write the decimal in digits:

zero ones, four tenths and five hundredths.

two ones, three tenths and four hundredths.

Percentages

42. Complete the missing percentages:

$$\underline{\hspace{2cm}}\% = \frac{50}{100} = \frac{1}{2}$$

$$41\% = \frac{\underline{\hspace{2cm}}}{100}$$

Solve Problems

Fractions

43. Adil divides his marbles into tenths. He wants to give two friends an equal number of marbles but still have 3 times more than their individual amounts. What fractions could he split his marbles into?

Measure and Money Problems

44. a) Ellie buys a new shirt for £4.75 and a pair of trousers for £3.50 in a sale. She pays with a £10 note. What change will she receive?

b) A bag of potatoes weigh 2.45kg. How much will 4 bags weigh?

Decimal Problems to 3 Decimal Places

45. A packet of sugar weighs 1.348kg. $\frac{3}{4}$ kg is used to bake some cakes.

How much will the packet weigh now?

Knowing Percentage and Decimal Equivalents

46. Order the following from smallest to largest:

25%, 0.3, $\frac{2}{5}$

Measurement

Estimate, Measure, Compare, Add and Subtract

47.

Lengths (mm/cm/m)

Measure and draw lines using a ruler in centimetres (cm) or millimetres (mm).

This line is _____cm or _____mm long.

Mass (g/kg)

Measure the mass of objects using different scales

48. 3 apples weigh 435g. One is eaten, and the 2 remaining apples weigh 285g. What is the mass of the eaten apple?

Capacity (ml/l)

49.

Circle the jug which has more water:

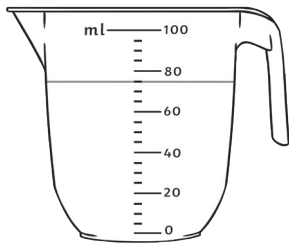

75ml

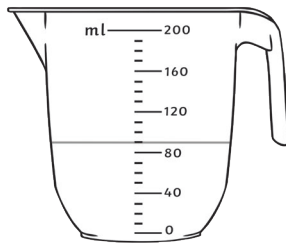

90ml

Convert between units

50.

Complete the missing conversions:

Length:

1 km = _____m

1m = _____cm or _____mm

1cm = _____mm

Mass:

1kg = _____g

Capacity/ Volume:

1l = _____ml

Time:

1 year = _____days

1 week = _____days

1 day = _____hours

1 hour = _____minutes

1 minute = _____seconds

Perimeter

51. Calculate the perimeter:

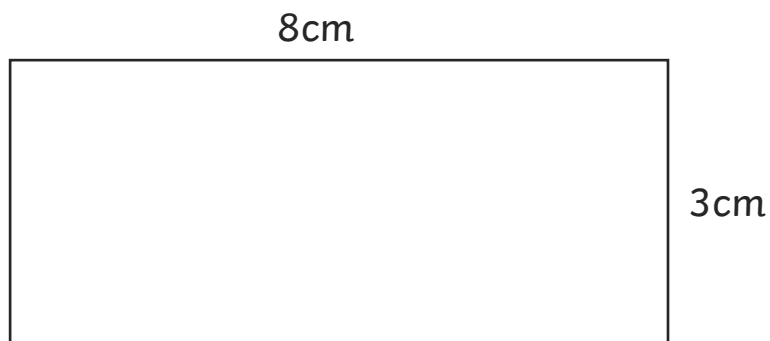

Perimeter = _____ cm.

Measure and calculate the perimeter of rectilinear shapes (including squares)

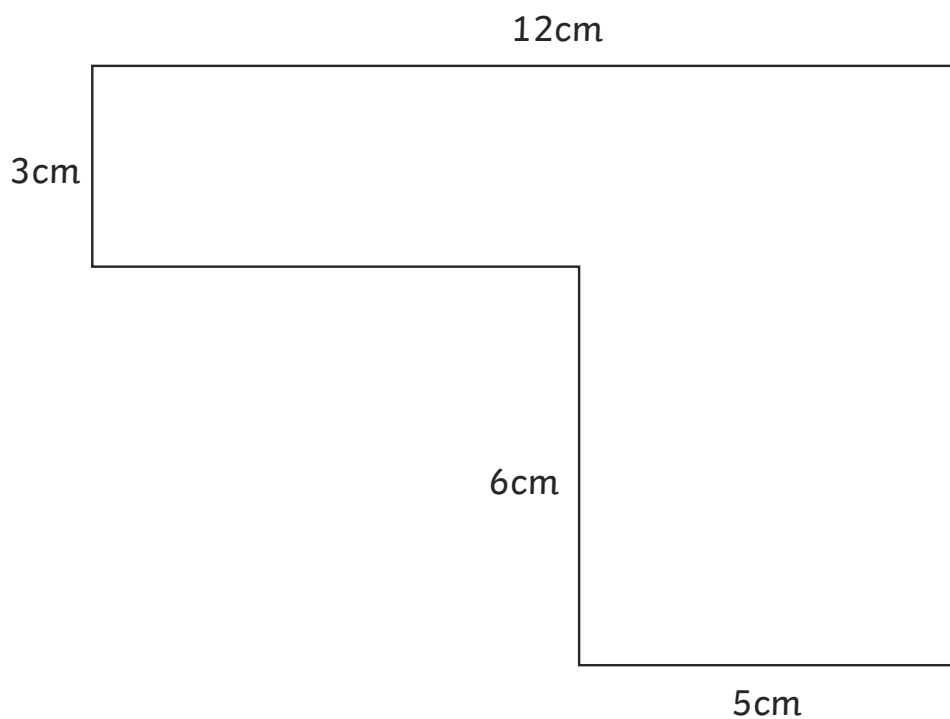

Perimeter = _____ cm.

Area

52. a) Calculate the area of this rectilinear shape by counting squares:

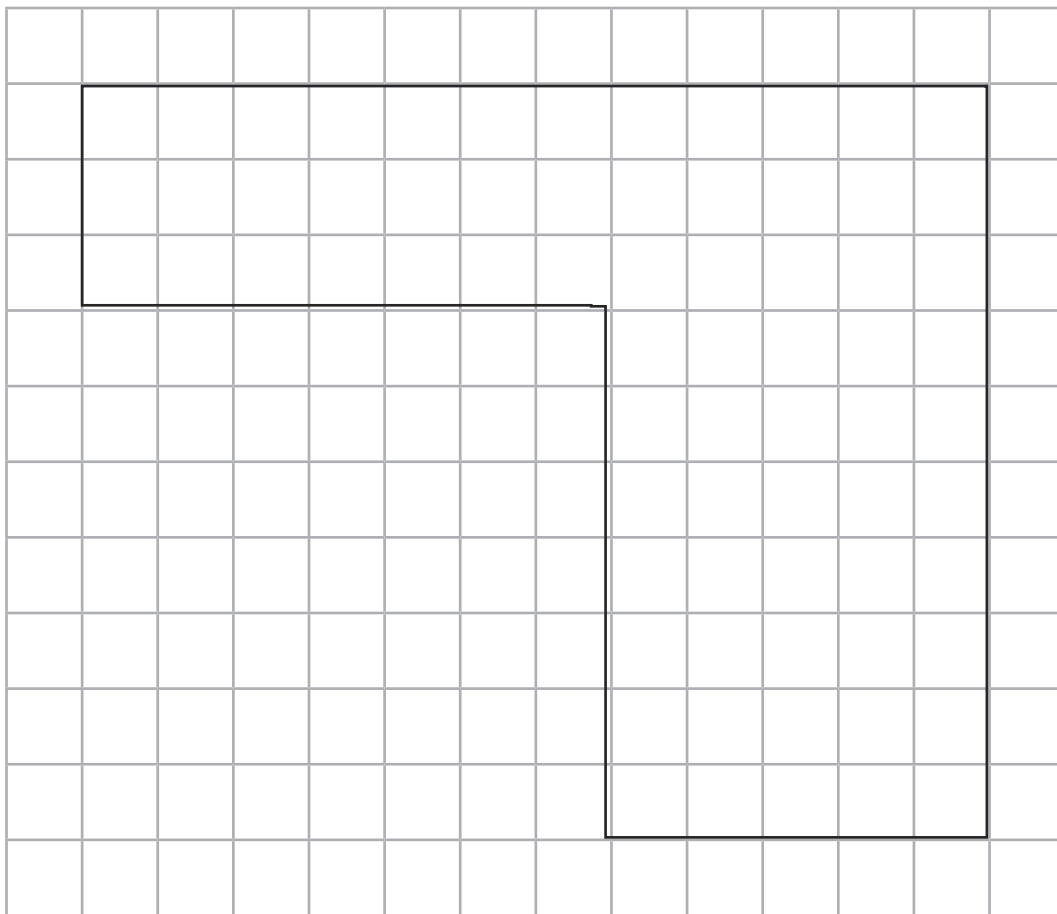

Area = _____ cm^2

b) Measure the sides of the rectangle and calculate the area:



Area = _____ $\text{cm} \times$ _____ $\text{cm} =$ _____ cm^2

c) Estimate the area of this irregular shape:

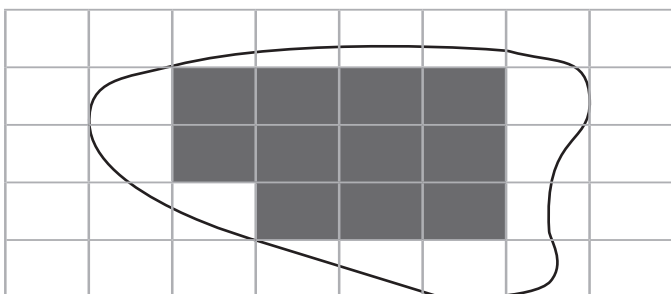

Money

53. Add and subtract giving change

Jude buys a bag of apples for £2.25 and some avocados for £3.15. How much change will he get from £20?

Time

54. Analogue clocks and 12/24 hour time

a) What time do these clocks show? _____

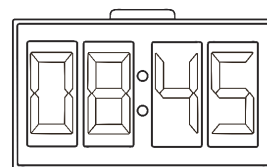
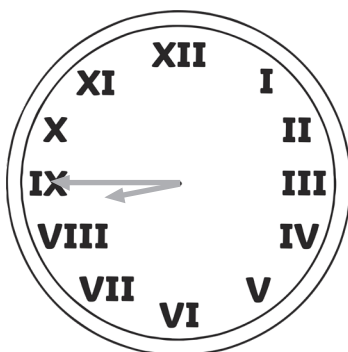
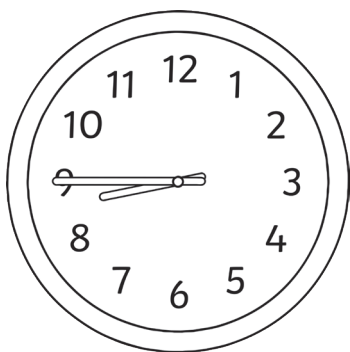

b) The maths lesson lasted 1 hour and 5 minutes. The art lesson was one hour and twenty minutes. Which lesson was longer and by how long? _____

c) A film lasts 136 minutes. How long is the film in hours and minutes?

_____ hours and _____ minutes

Solve Problems

55. a) 2 equal bottles of water contain 500ml of drink. How many litres will 7 bottles hold?

b) A 6.5kg bag of soil is divided into 20 pots equally. Each pot needs 0.5kg. How much more soil does each pot need after the bag is used up?

2D Shapes

56. Label the shapes.

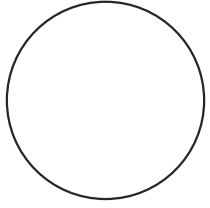

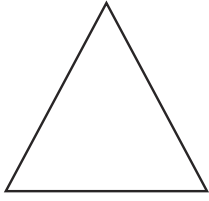

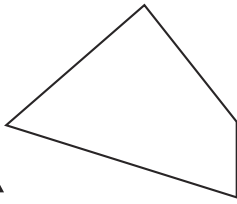



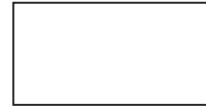

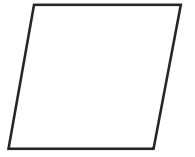



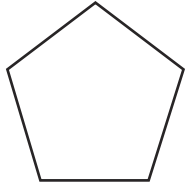

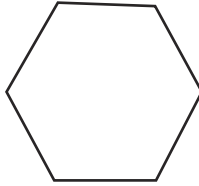

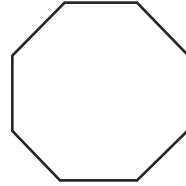

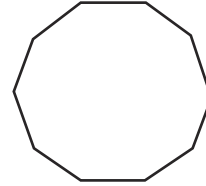

57. Draw a square on 1cm squared paper with sides of 4cm.

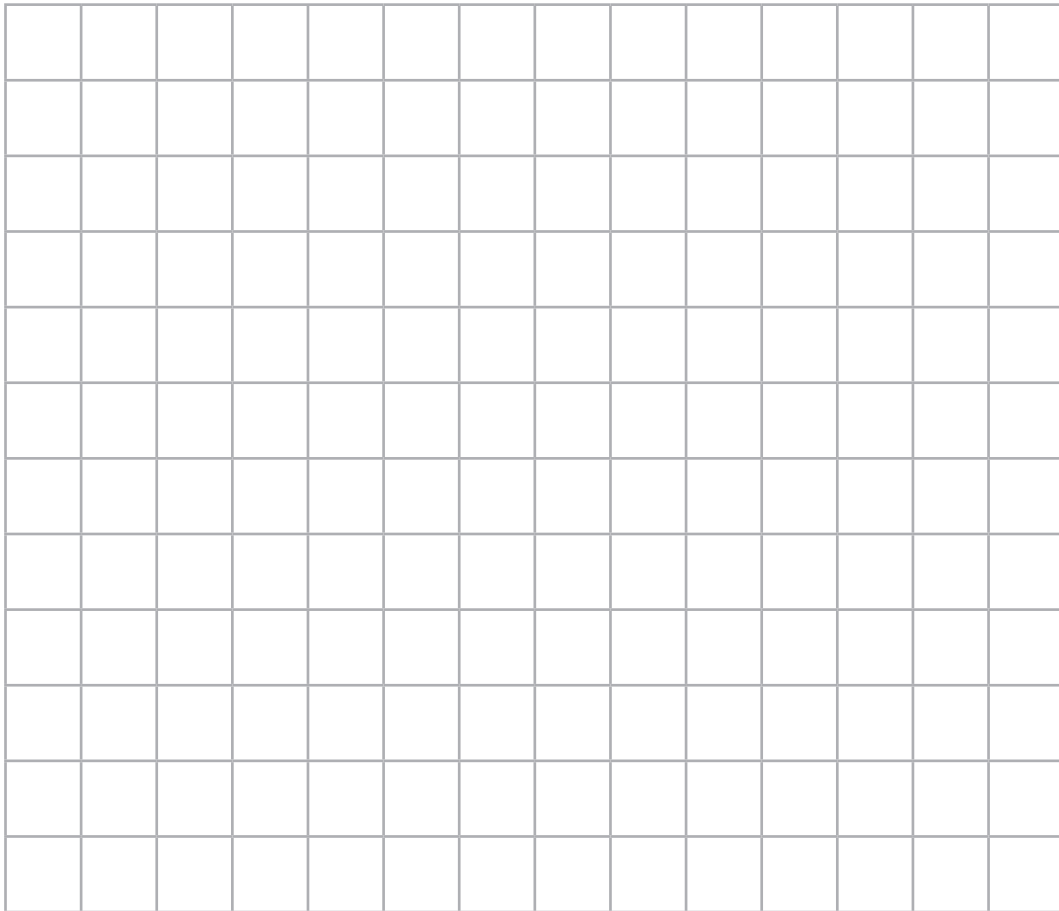

58. Write suitable titles for this Venn diagram:

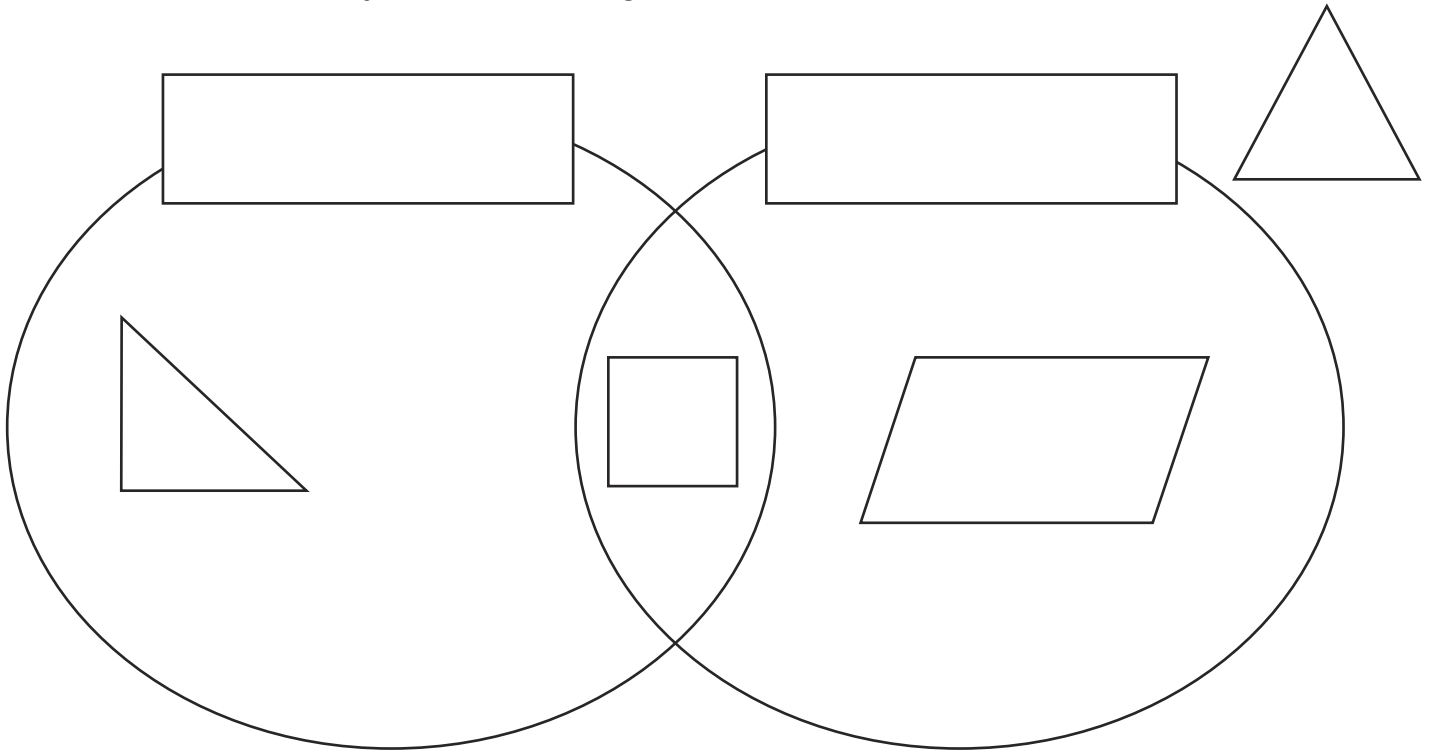

Triangles

59. Label the triangles.

_____ (all sides and angles equal)

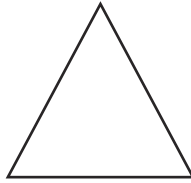

_____ (2 sides and angles equal)



_____ (no sides and angles equal)

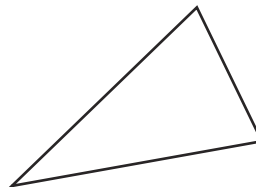

_____ (one angle a right angle)

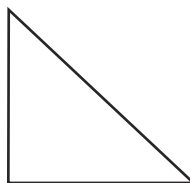

3D Shapes

60. Label the shapes:

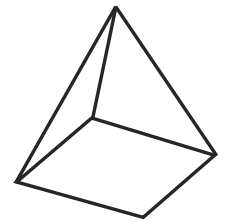
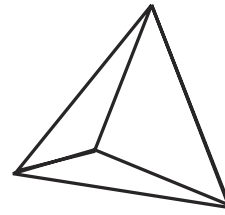
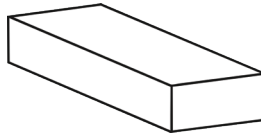
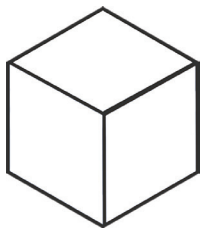
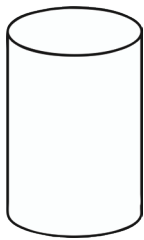
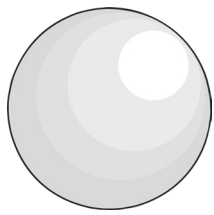

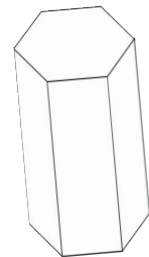
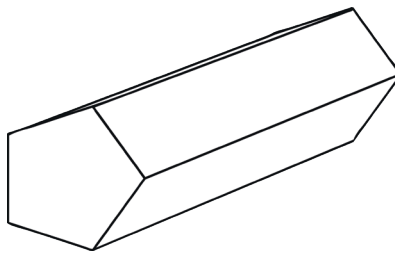
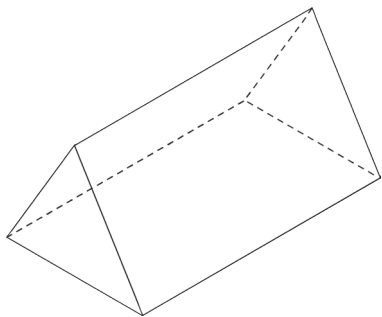

Recognise 2D representations and make models from modelling materials

Angles

61. Complete the statements:

An _____ measures a turn.

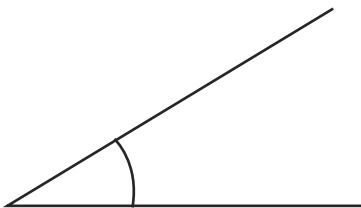

A _____ _____ is the corner of a square.

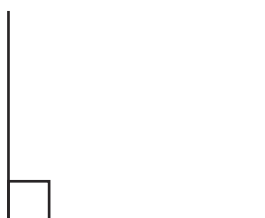

_____ right angles make a straight line.

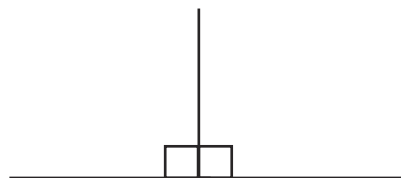

An _____ angle is less than a right angle (90°).

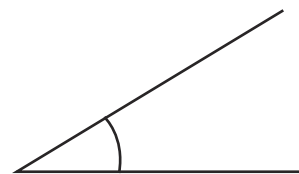

An _____ angle is between a right angle and a straight line.



Draw and Measure Angles

62. a) Measure the angle: _____

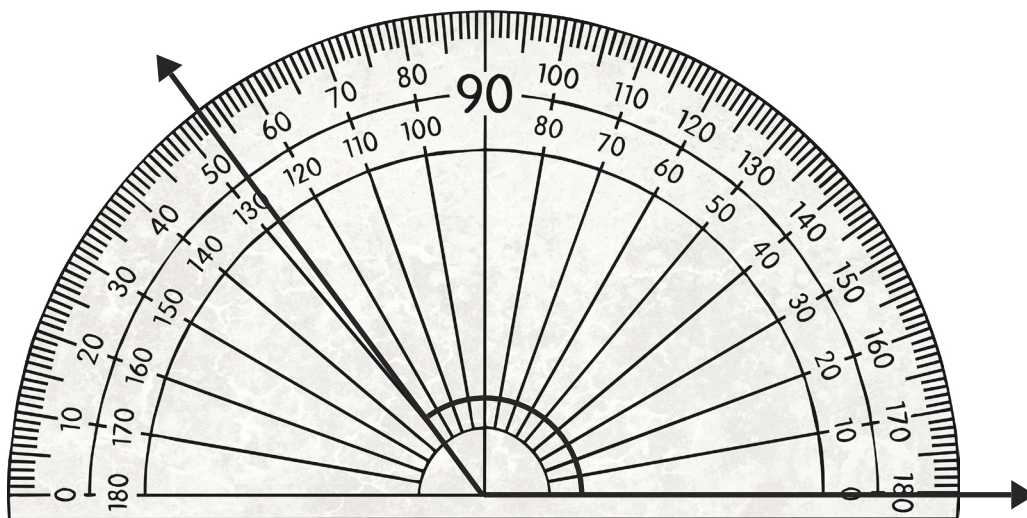

b) Calculate the missing angles:

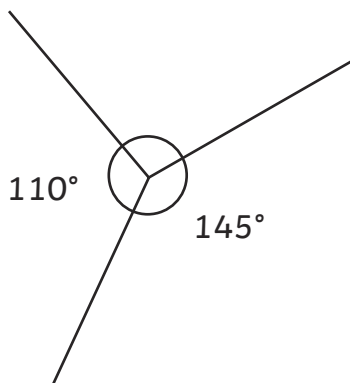

c)

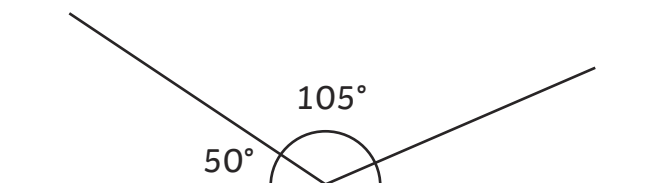

One right angle = _____° Two right angles = _____° Three right angles = _____°

Lines

63. Label the lines using the word bank:

vertical
parallel
horizontal
perpendicular

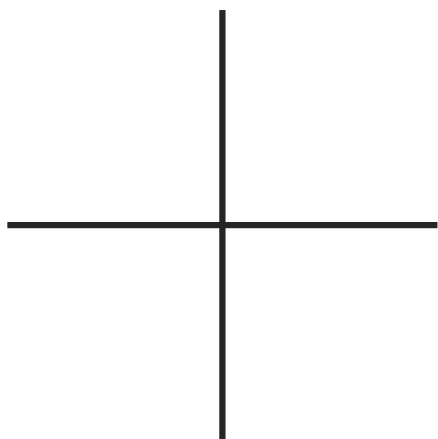

Symmetry

64. Mark the lines of symmetry in these shapes:

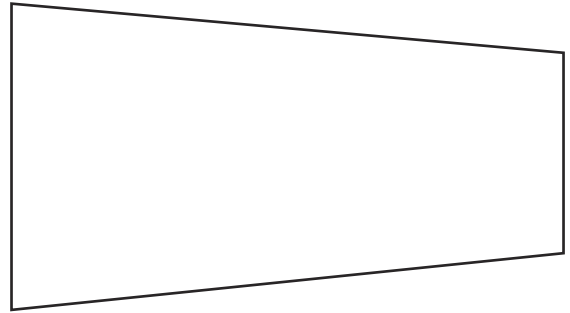
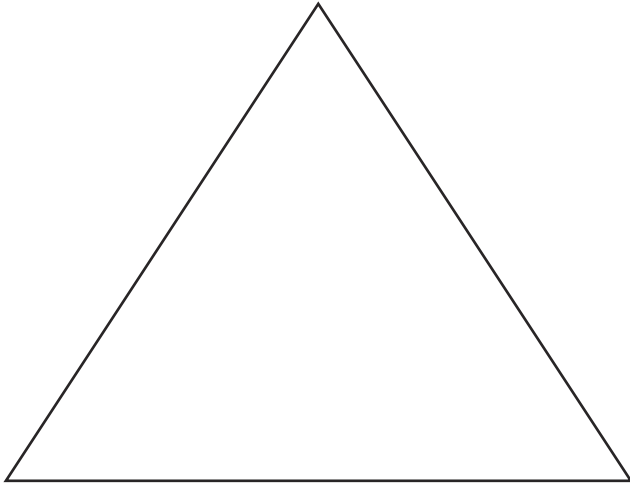

Complete the symmetrical figure:

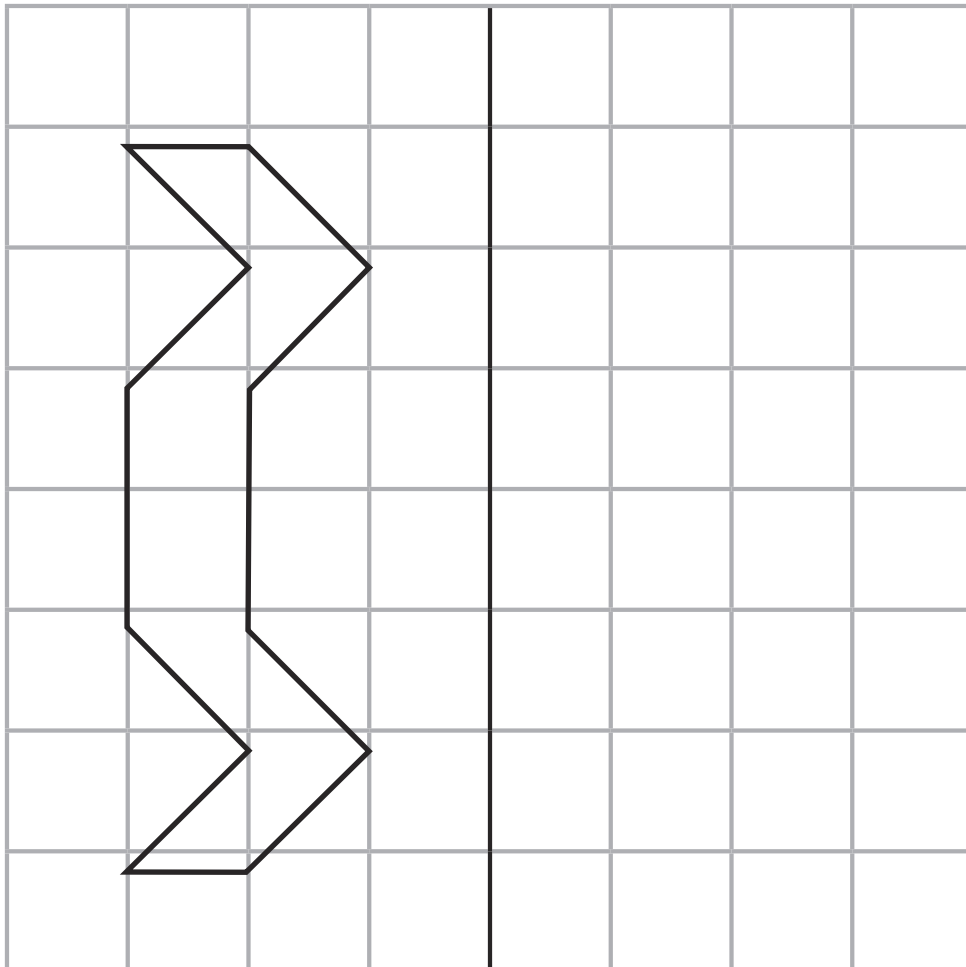

Regular and Irregular Polygons

65. Circle the regular polygons:

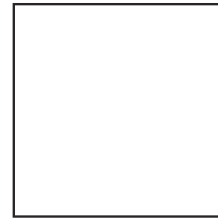
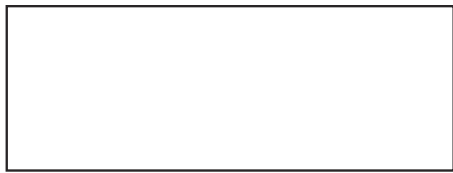
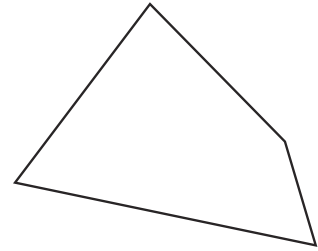
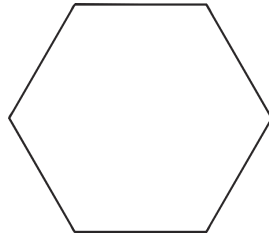
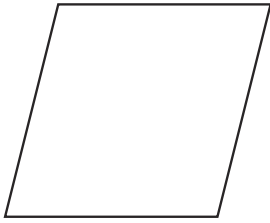

Geometry – Position and Direction

Coordinates

66.

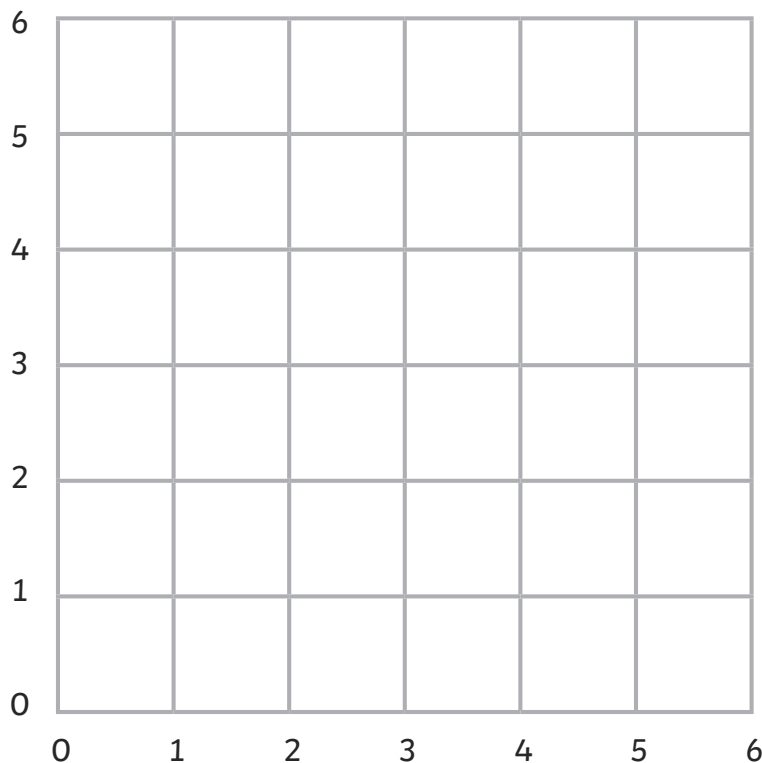

Label A, B and C The coordinates are

A (1,3)

B (2,4)

C (4,2)

What are the coordinates of the point that will complete a rectangle? _____

Translation

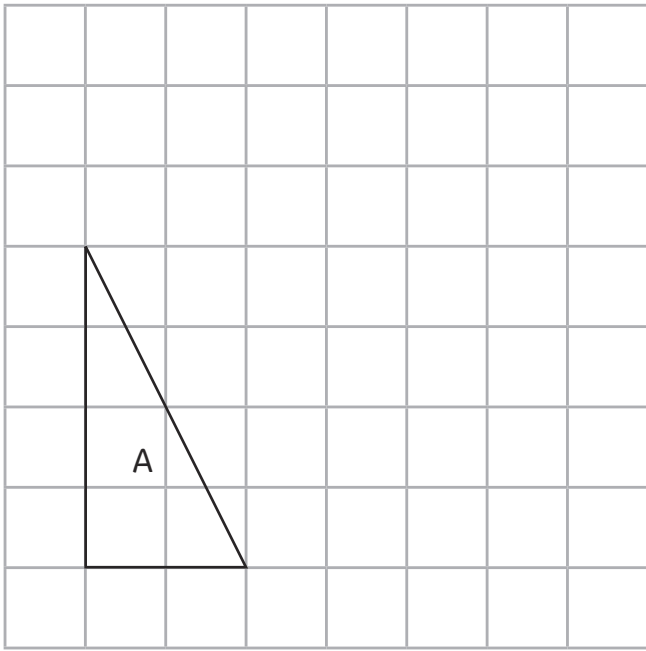

The triangle A is translated three squares to the right and two squares up to triangle B.

Mark triangle B

Reflection

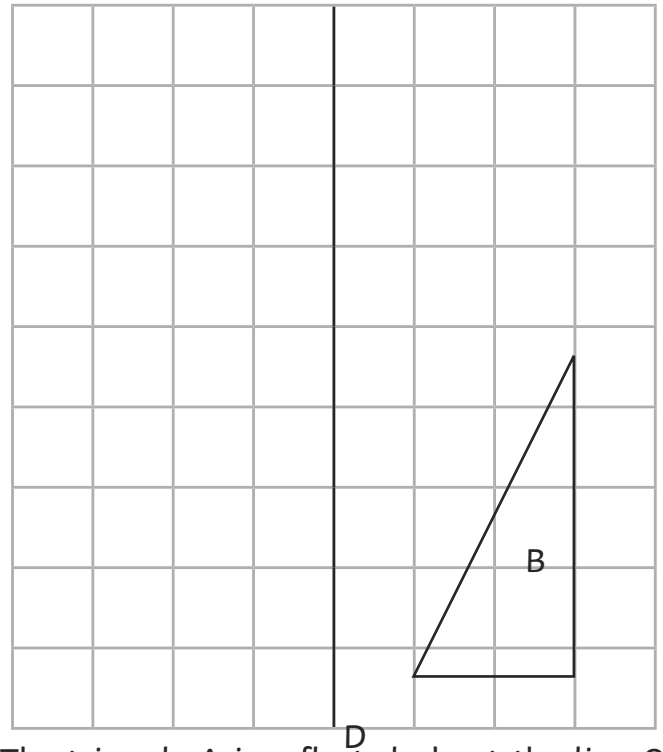

The triangle A is reflected about the line CD to triangle B.

Statistics

67. Present data in these graphs and tables and solve problems:

Pictograms

Favourite Colour

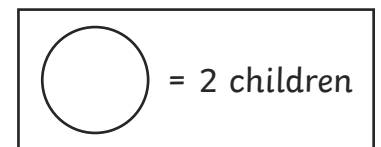
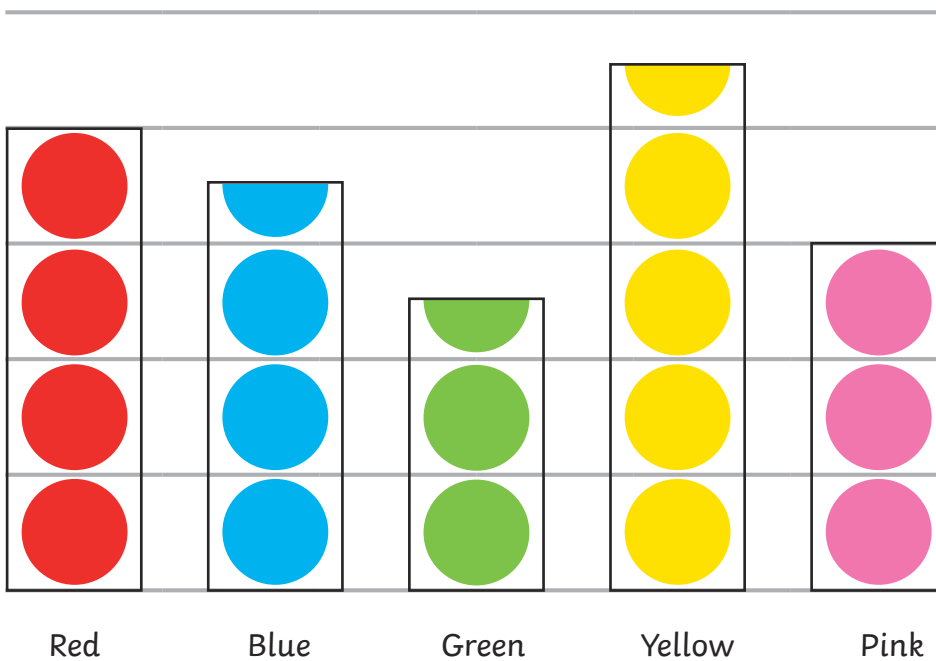

a) How many children chose their favourite colour? _____

Bar Charts

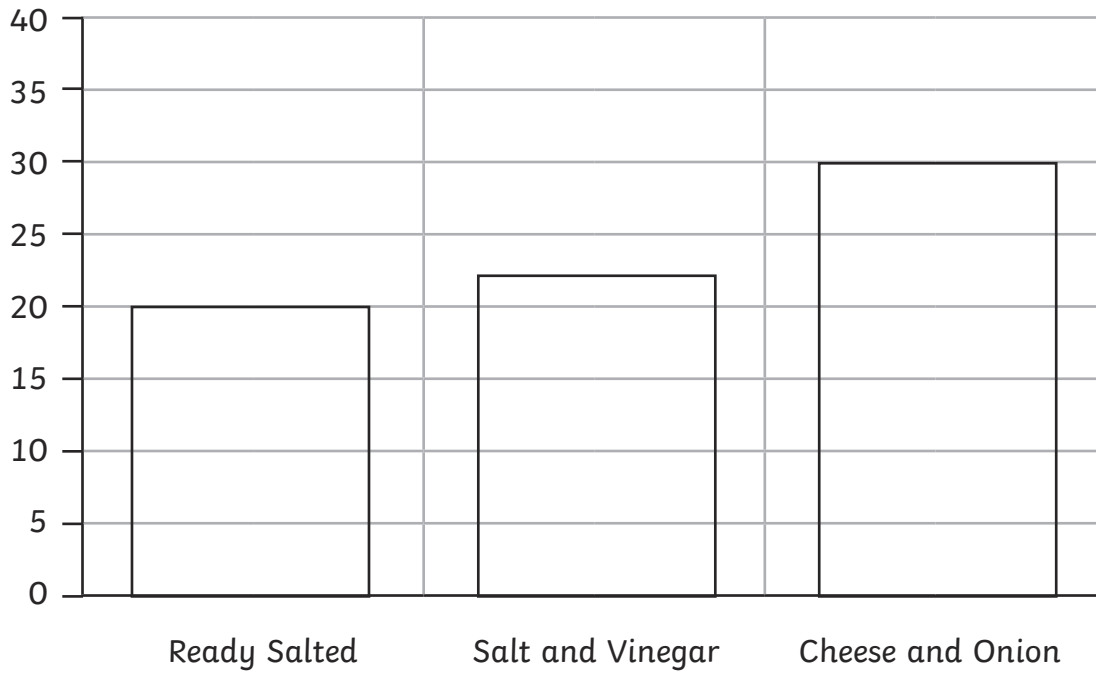

a) How many more children chose cheese and onion as their favourite crisps than ready salted?

The Height of Children

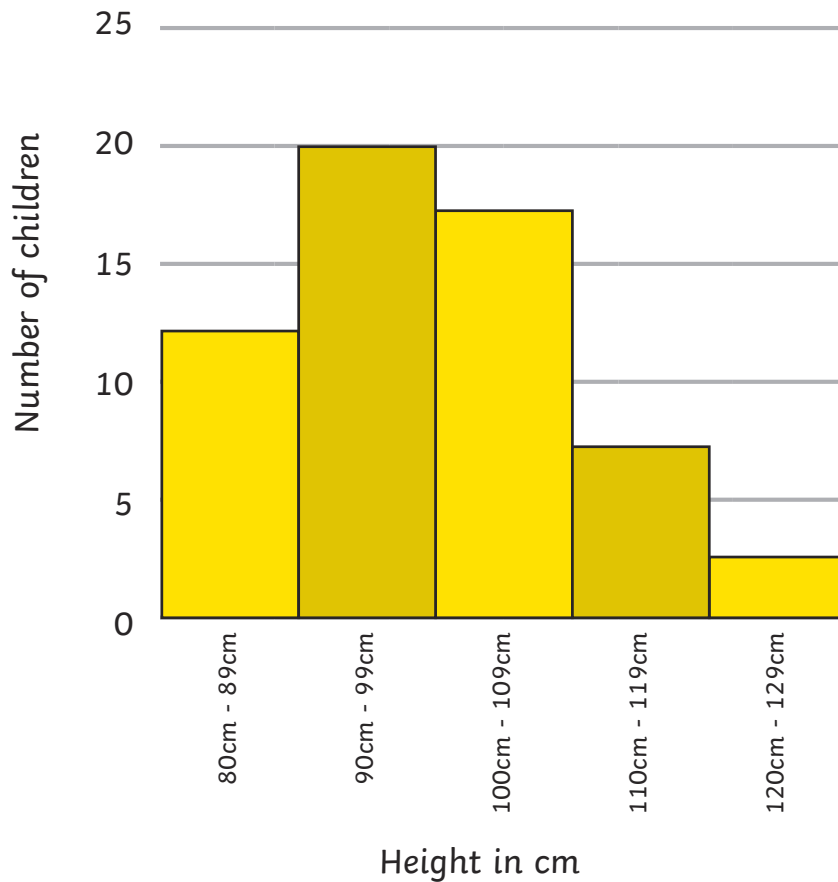

c) How many children are shorter than 1m? _____

Tables

| | Monday | Tuesday | Wednesday | Thursday |
|----------|--------|---------|-----------|----------|
| Saturn | 2 | 1 | 3 | 4 |
| Twin | 0 | 2 | 2 | 3 |
| Stars | 5 | 3 | 2 | 0 |
| Cluster | 2 | 2 | 2 | 2 |
| Treasure | 1 | 3 | 5 | 0 |
| Tiger | 6 | 3 | 4 | 1 |
| Plimmy | 1 | 3 | 2 | 2 |

d) Which chocolate bar is the most popular? _____

Time Graphs

Number of Children Who Have a School Meal

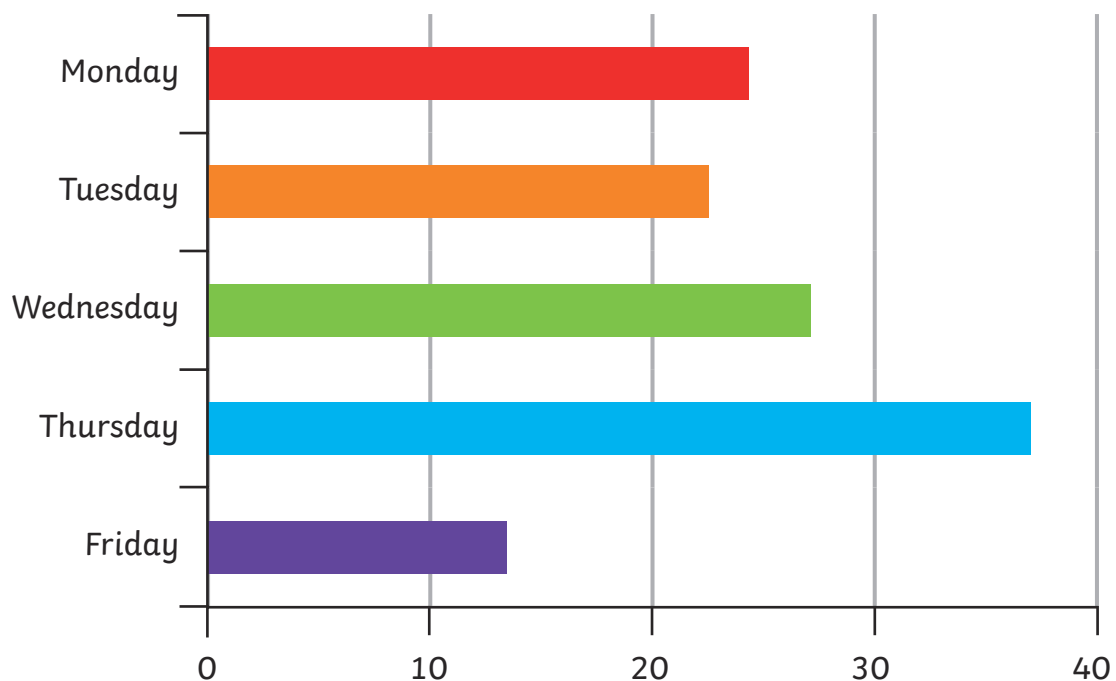

e) How many children had a school meal during the week? _____

Line Graphs

Length of a Shadow

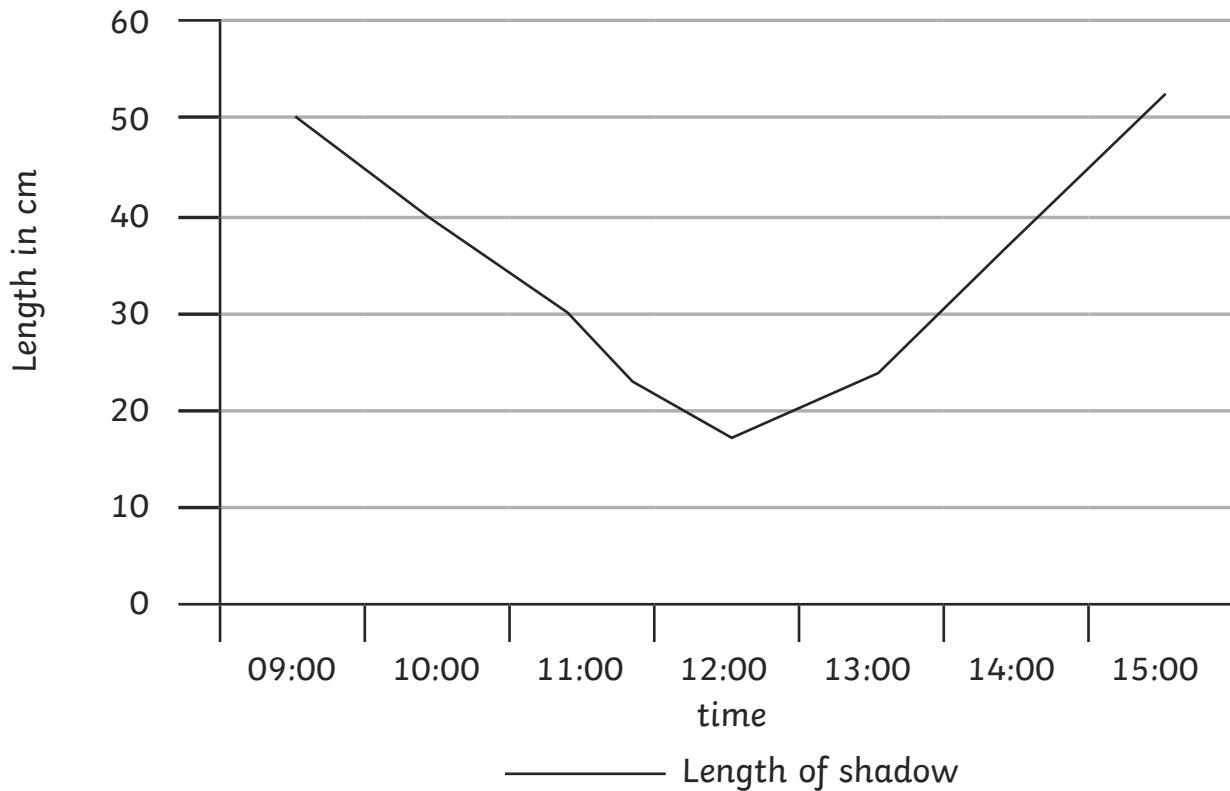

f) In which hour was the largest change in the length of the shadow? _____

Time Graphs

Train timetable from London to Newcastle

| Destination | Journey A | Journey B | Journey C |
|-------------|-----------|-----------|-----------|
| London | 10:20 | 11:30 | 16:40 |
| Derby | 12:20 | | 18:00 |
| Sheffield | 12:40 | 13:10 | 18:30 |
| Hull | 13:20 | 13:55 | 19:15 |
| Newcastle | 14:25 | 14:40 | |

g) Which train takes the least time to get from London to Hull? _____