

creative
play

Playground Design Home Learning Pack

#playgroundprize



Introduction

During the Covid-19 challenge that we are all currently facing, schools are being asked to look after the children of key workers as well as supporting children who are staying home with home learning resources. We think that the schools, teachers and parents are doing this amazingly and we wanted to support you in any way we can and to say.....

THANK YOU!

This resource pack is full of activities, linked with creating a playground, that can be completed by those who are home learning. Complete the activities and submit them back to us to be in with a chance of winning a new playground worth more than £10,000 for your school!

All the information you need is included within the pack, good luck and most importantly – have fun!

‘Play turns out to be so stunningly essential to childhood, it’s like love, sunshine and broccoli all juiced together’

(Lenore Skenazy, President of Let Grow www.letgrow.org)



Show us what you are doing

Make sure to use the #playgroundprize



Facebook – @CreativePlayUK



Twitter – @CreativePlayUK



Instagram – @CreativePlayUK



Whatsapp – 07515 328121

What to do...

Complete all the activities in the pack for your chance to win a playground for your school!

We'd love to see pictures of you having fun and completing the activities!
Why not send them to us via facebook, twitter or email.

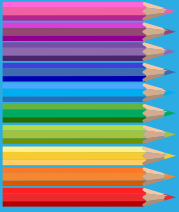

1. Design your playground

Draw your perfect playground with all your favourite features
Make sure to colour it in!

2. Draw your equipment

Design a piece of play equipment for your playground
Make sure to label it!

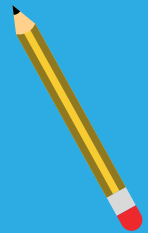

3. Questionnaire

Fill in the playground design questionnaire
Make sure you tell us everything about your playground!

4. Tell us why

Write us a letter, telling us why you would like this playground
Make sure to use your best handwriting!



5. Details

Get your parent to fill in the school details
Make sure they do it!

6. Choose a prize

If you win, this will be installed at your school
Make sure you only choose one!



7. Submit your playground design pack

Submit all your tasks to play@creativeplayuk.com by the 1st of May
Make sure you have finished everything!

#playgroundprize

Designing your perfect playground

Using the Creative Play paper (provided), draw your own perfect playground.

Think about the space you have at school and where a playground could go.

Will all the items you would like fit?

Would everyone be able to use it?

Use the Creative Play website for inspiration.

Once you have designed the outline of your playground, get creative. Try adding in trees, fences etc. Make sure to colour the whole drawing in!

Equipment you will need:

- Pencil or Pen
- Creative Play Paper
- Colouring Pencils/ Pens

The bigger you can do your drawing the better!

If you don't have a printer just use plain paper

Dont forget to label the equipment so everyone knows what it is!

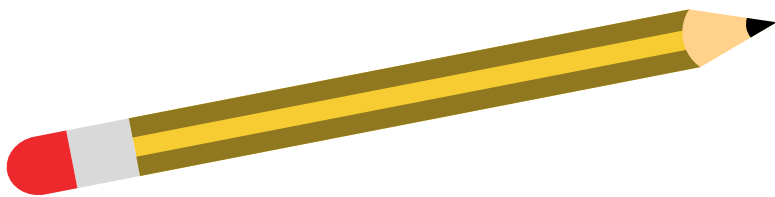

Send us photos of you doing this via social media use #playgroundprize

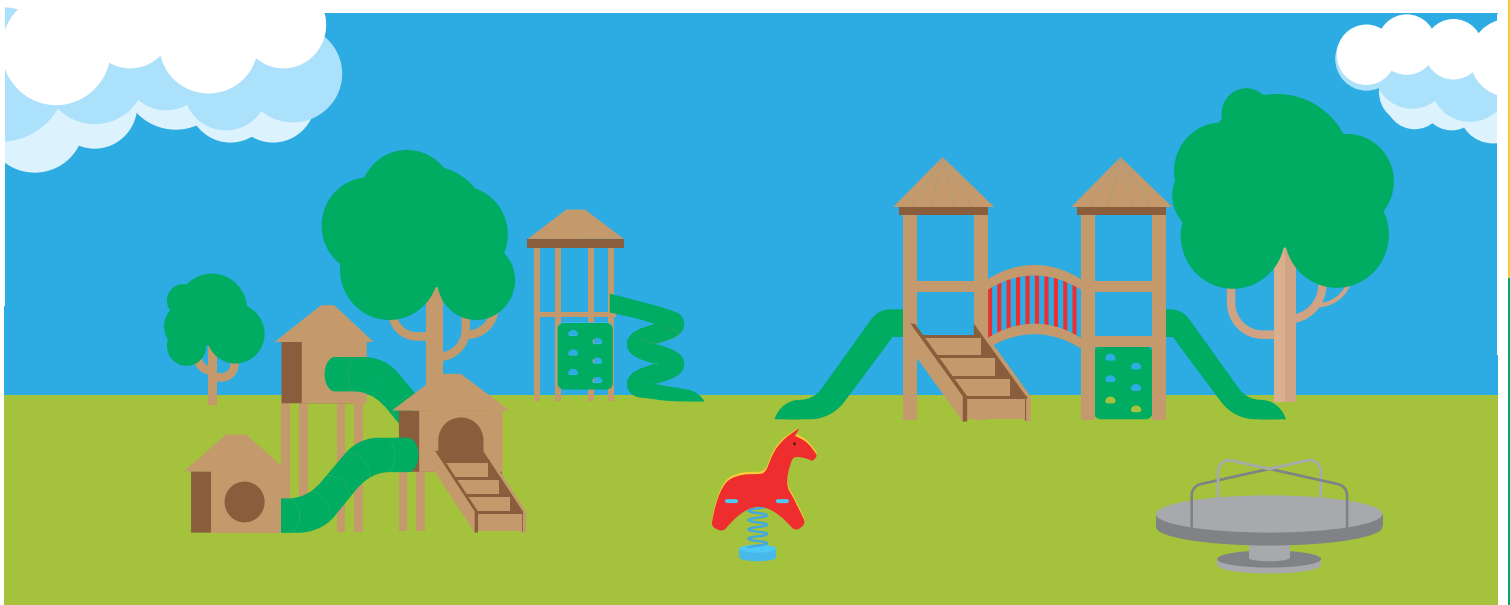

Design a piece of play equipment

Using the Creative Play paper, design a piece of playground equipment.

Think about what play features it has.

Can you climb on it?

Would everyone be able to use it?

You can use the Creative Play website for inspiration.

Once you have designed your equipment label it with the measurements and its features.

Equipment you will need:

- Pencil or Pen
- Creative Play Paper
- Colouring Pencils/ Pens

The bigger you can do your drawing the better!

If you don't have a printer just use plain paper



Send us photos of you doing this via social media use #playgroundprize

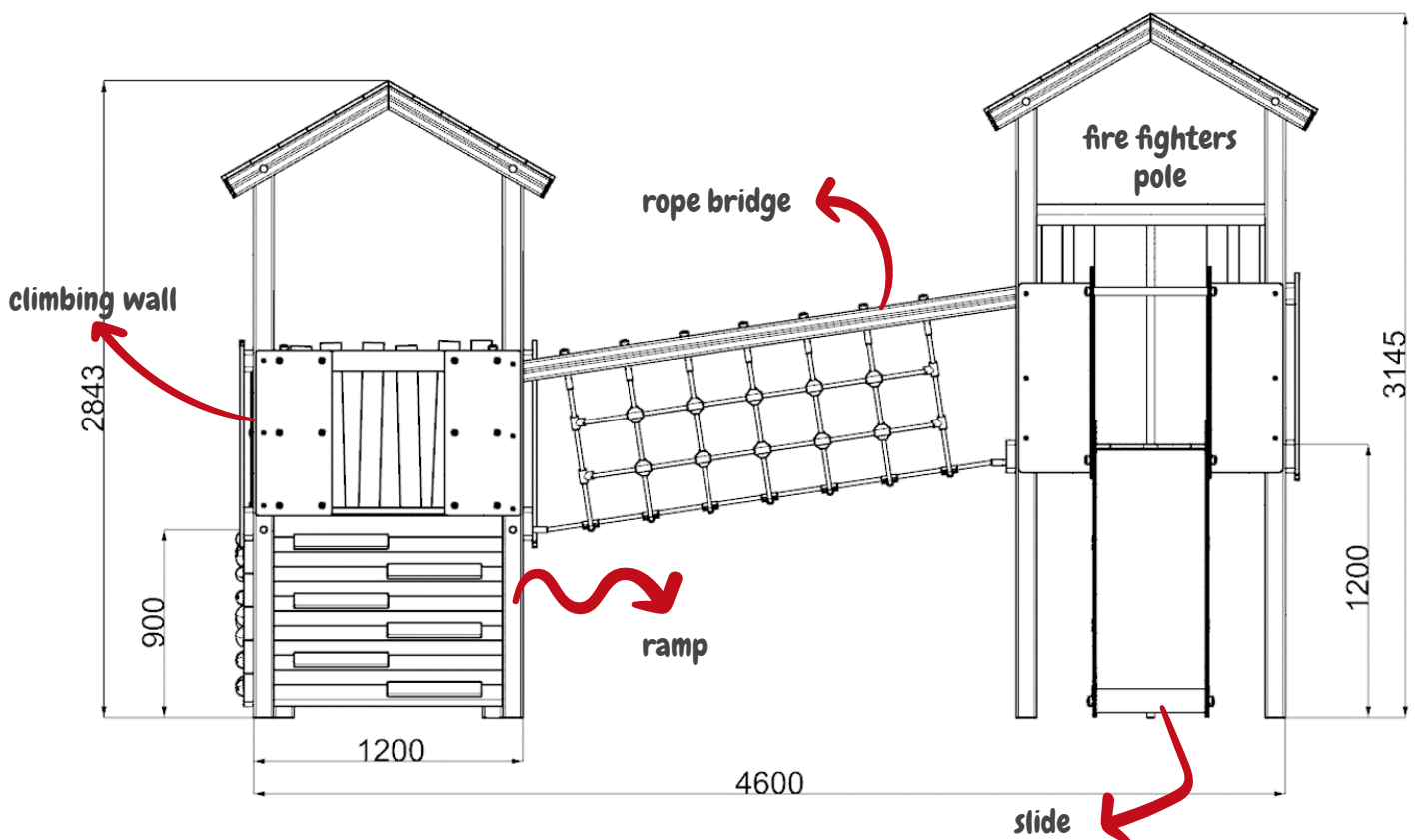

Write us a letter

We want you to tell us why your school should win a playground.
As part of your competition entry pack, think about any playground equipment you think your school is missing.
It could be equipment to play games with or even something slightly larger.
Tell us why you think a new playground is needed and what you would use it for.

Dear Creative Play,

I am writing to you to

.....
.....
.....
.....
.....
.....
.....
.....
.....
.....
.....
.....
.....
.....
.....
.....
.....

The equipment would be used for

.....
.....
.....
.....
.....
.....
.....
.....
.....
.....
.....
.....
.....
.....
.....
.....
.....
.....
.....
.....
.....
.....

I think this would really help the pupils of our school to

.....
.....
.....
.....
.....
.....
.....
.....
.....
.....
.....
.....
.....
.....
.....
.....
.....
.....
.....
.....
.....
.....

Yours sincerely,

.....
.....
.....
.....

You can use this template or write your own using your best handwriting.

Entry Details

Get your parent to fill this one in...

School Name

.....

School Postcode

.....

School Email Address

.....

School Phone Number

.....

Student Name

.....

Parent Email Address

.....

We are happy for all information we send through to be used as marketing material by Creative Play

YES

NO

We are happy for all information we send through to be used as technical resources for Creative Play

YES

NO

How to submit your playground design pack:

Scan all of your activities or take photos of them

Email your whole submission to play@creativeplayuk.com

Use the subject line **Creative Play Playground Competition – School Name – Postcode**

If you have any questions or queries, please email play@creativeplayuk.com

Parents – you will need to complete the Entry Details form before submitting



Choose a prize!

If you are lucky enough to win, which one of these products would you choose as a prize*? Tick 1 of the products below

* subject to space and survey restrictions

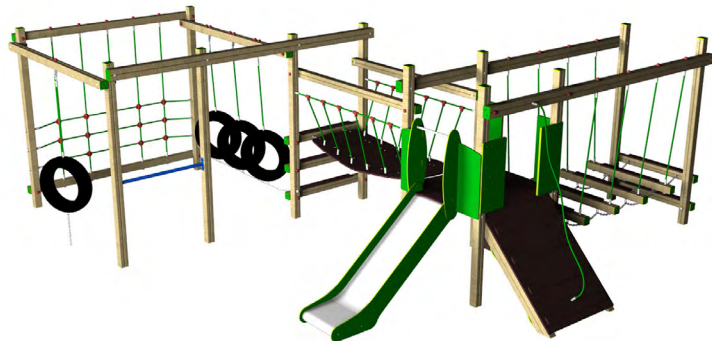

Option 1

**Dart
Activity Centre**

with surfacing

Suitable on tarmac
or grass

Suitable onto tarmac
or grass

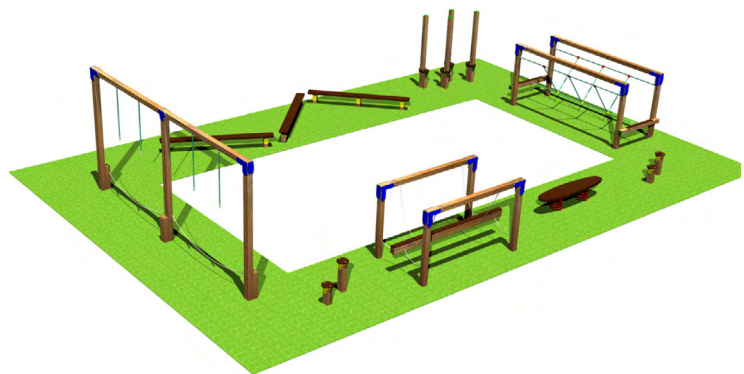

Option 2

**Potomac
Trail**

with surfacing

Check out the Product Information Sheets or our website for more information on each product**

**Try clicking on each product to go to our website



Option 3

Discovery Jigsaw Tower

Suitable on grass only

Suitable on grass only

Option 4 Mississippi Trail

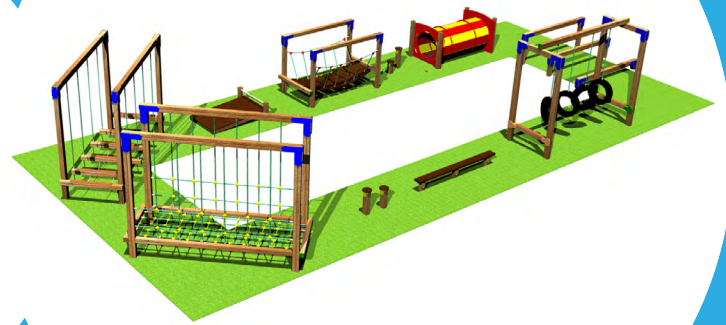

Option 5

Adventure Trail 16

Suitable on grass only

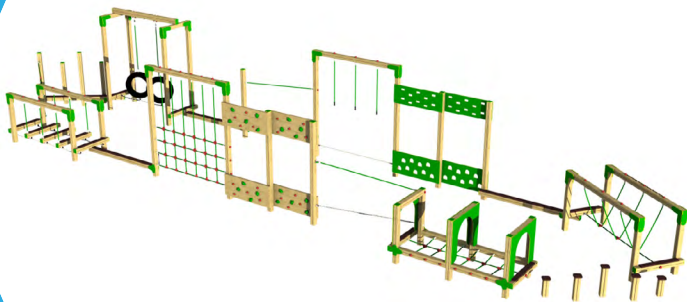

Terms & Conditions

- No purchase necessary.
- Competition entries must be received by 5pm on Friday 1st May 2020. Voting will take place between 11am Monday 4th May 2020 and 3pm Thursday 14th May 2020 with the winner announce on Friday 15th May 2020
- Multiple entries are allowed. Entrants may not win more than one prize.
- The prize is non-transferable and there are no cash alternatives. Creative Play reserves the right to amend the specification of the prize or offer an alternative prize. In exceptional circumstances, the Promoter reserves the right to foreclose the competition without notice.
- The entrant may upgrade their prize subject to additional cost.
- The competition is open to UK mainland schools only.
- By submitting an entry it is assumed that you have authority to do so.
- Entrants agree to Creative Play using their details in marketing and publicity. Your details will not be used for any other purpose, or passed onto any third parties, unless specified.
- Entrants agree that all material submitted to Creative Play can be used free of copyright for marketing purposes including written competition entries, photographs and social media messages.
- We will contact winners by email. In the event of a winner not responding after 7 days, we reserve the right to allocate the prize to another winner, or foreclose the prize. Unsuccessful entrants will not be contacted. The winning school will be announced vis email, website and social media.
- Creative Play accepts no responsibility for entries that are incomplete, illegible, incorrect, corrupted or fail to reach Creative Play by the closing date for any reason. Automatically generated entries or entries via third parties are invalid and shall not be considered.
- Creative Play's decision is final and no correspondence will be entered into.
- The competition is subject to Creative Play's usual terms and conditions <https://creativeplayuk.com/terms-and-conditions/>



Potomac Trail

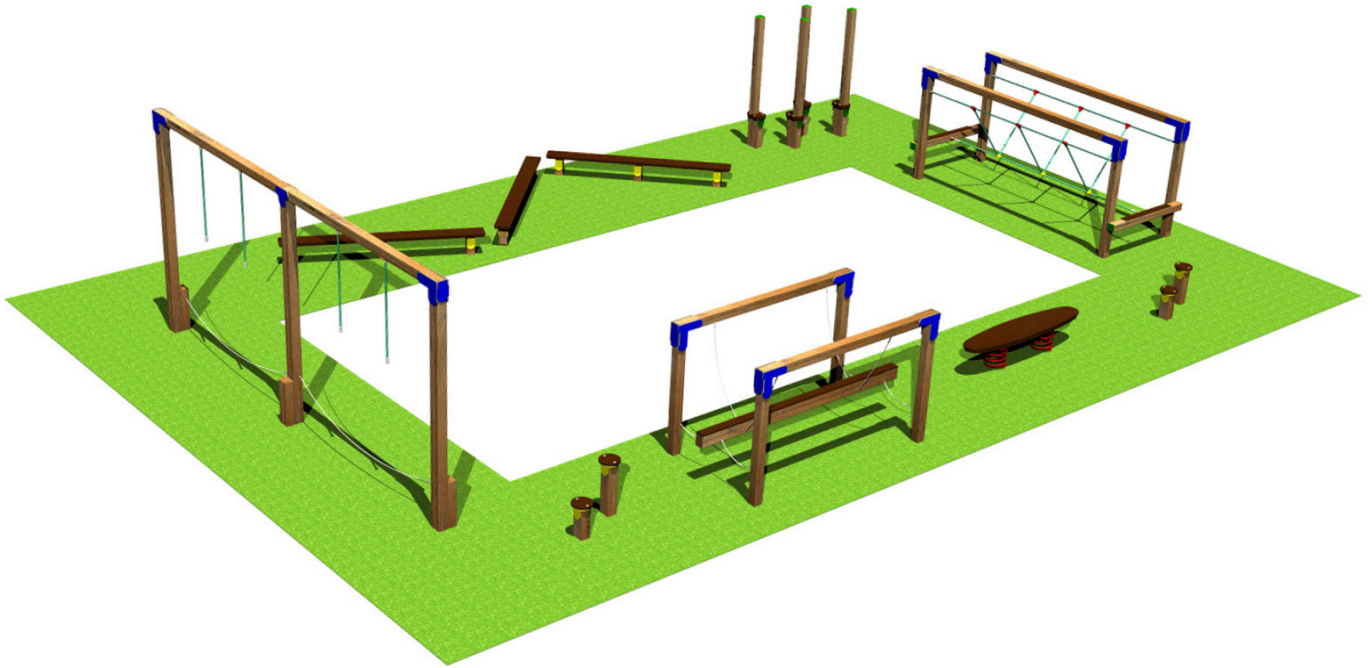

Example only. Space required and surfacing subject to design

Jelly Board/ Rope Bridge/ Zig-Zag Beam/ Rope Walk/ Stepping Logs/
Stilts/ Swinging Log

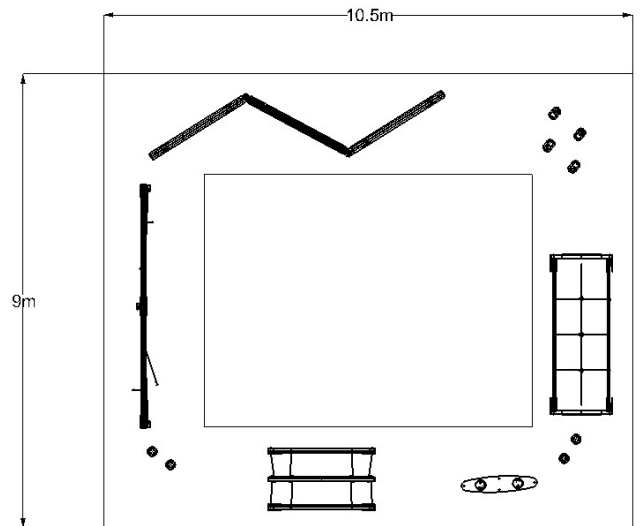

Free Fall Height: 0.60m
Space Required: 9.00m x 10.50m
Minimum Surfacing Area: 95m²

 **MADE IN
BRITAIN**

Dart Activity Centre

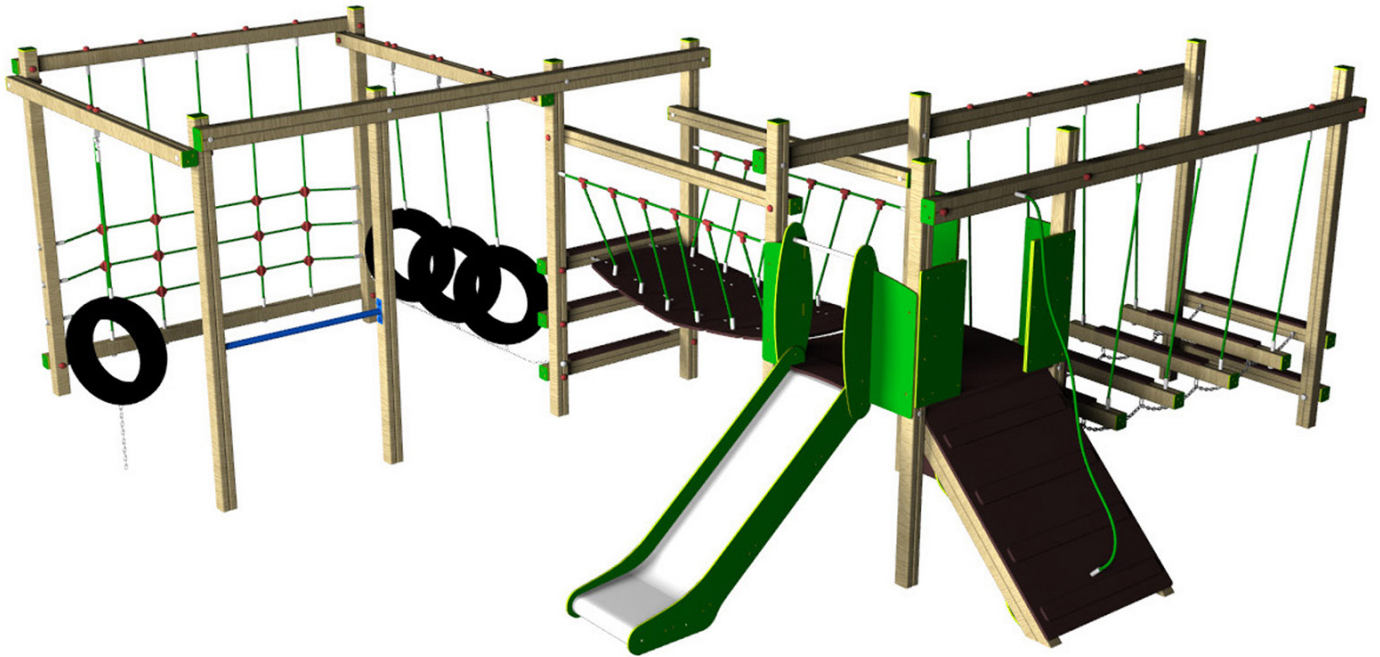

Slide with Playtec surround/ Tyre Crossing/ Clatterbridge/ Log Walk/ Rope Climb/
Climbing Panel/ Pull Up Bar/ Tyre Swing

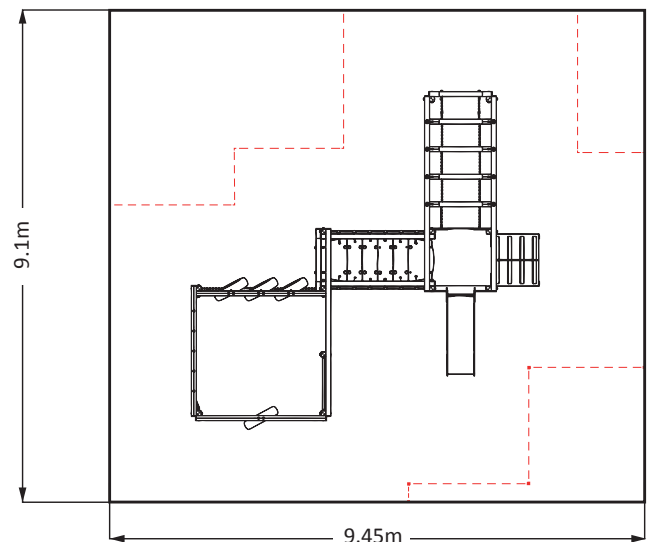
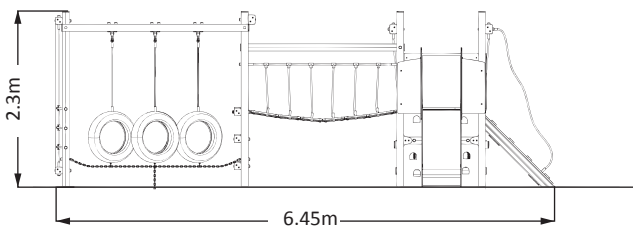
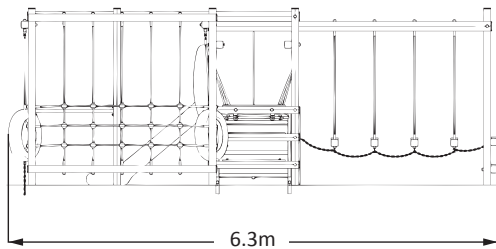

Free Fall Height: 1.20m
Space Required: 9.10m x 9.45m
Minimum Surfacing Area: 66m²

 **MADE IN
BRITAIN**

Discovery Jigsaw Tower



Slides / Log Climber / Climbing Panel / Inclined Staggered Walkway / Inclined V-Bridge / Stairs /
3 x Platforms – 0.9m, 1.2m & 1.5m

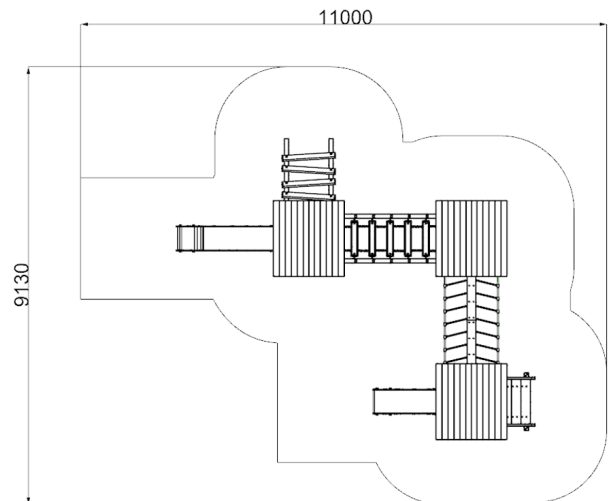
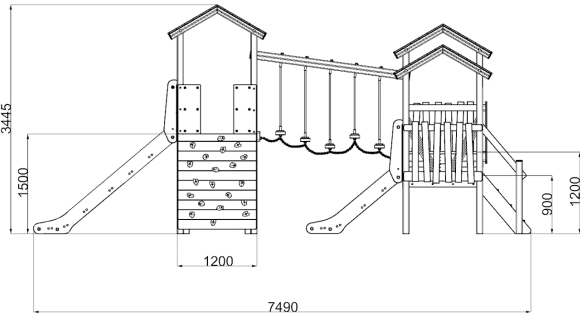

Free Fall Height: 1.50m
Space Required: 11.00m x 9.13m
Minimum Surfacing Area: 64m²

 **MADE IN
BRITAIN**

Mississippi Trail

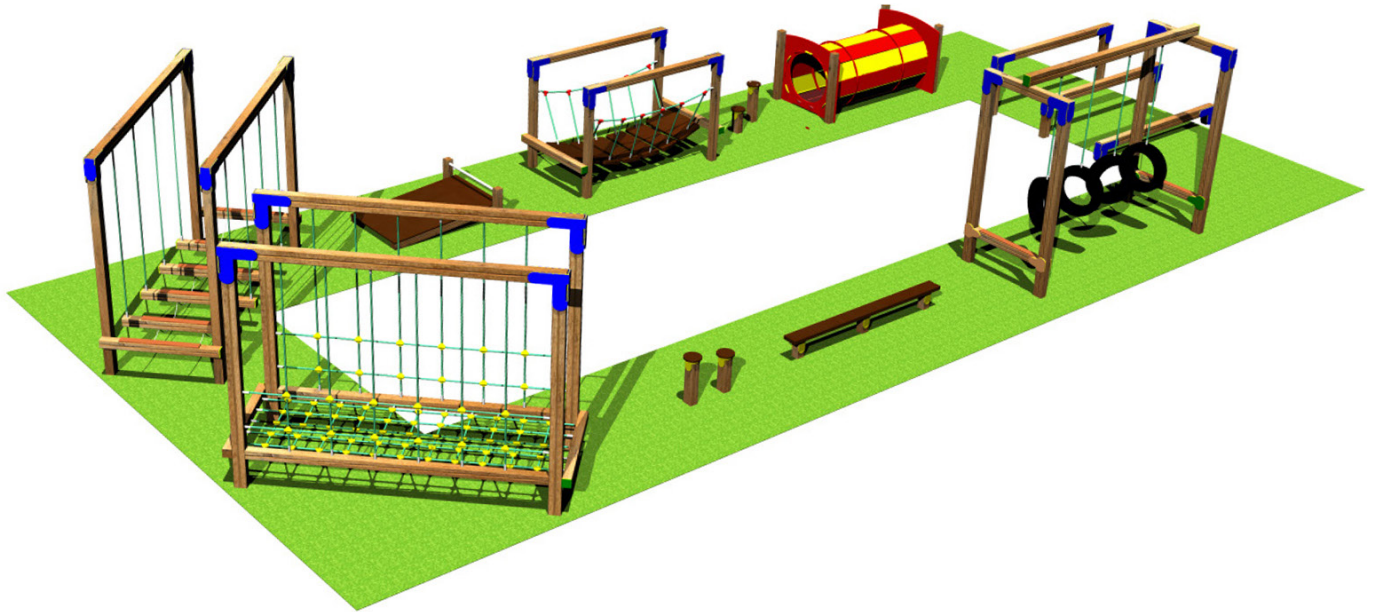

Example only. Space required and surfacing subject to design

Crawling Tube/ Tyre Crossing/ Balance Beam/ Stepping Log/ Net Tunnel/
Log Walk/ Sit Ups/ Clatterbridge/ Hurdles

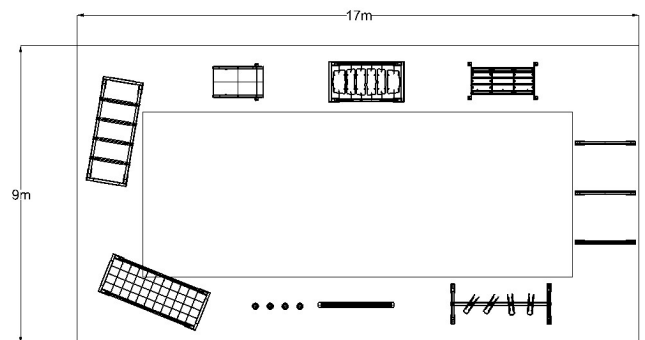

Free Fall Height: 1.10m
Space Required: 9.00m x 17.00m
Minimum Surfacing Area: 153m²

 **MADE IN
BRITAIN**

Adventure Trail 16

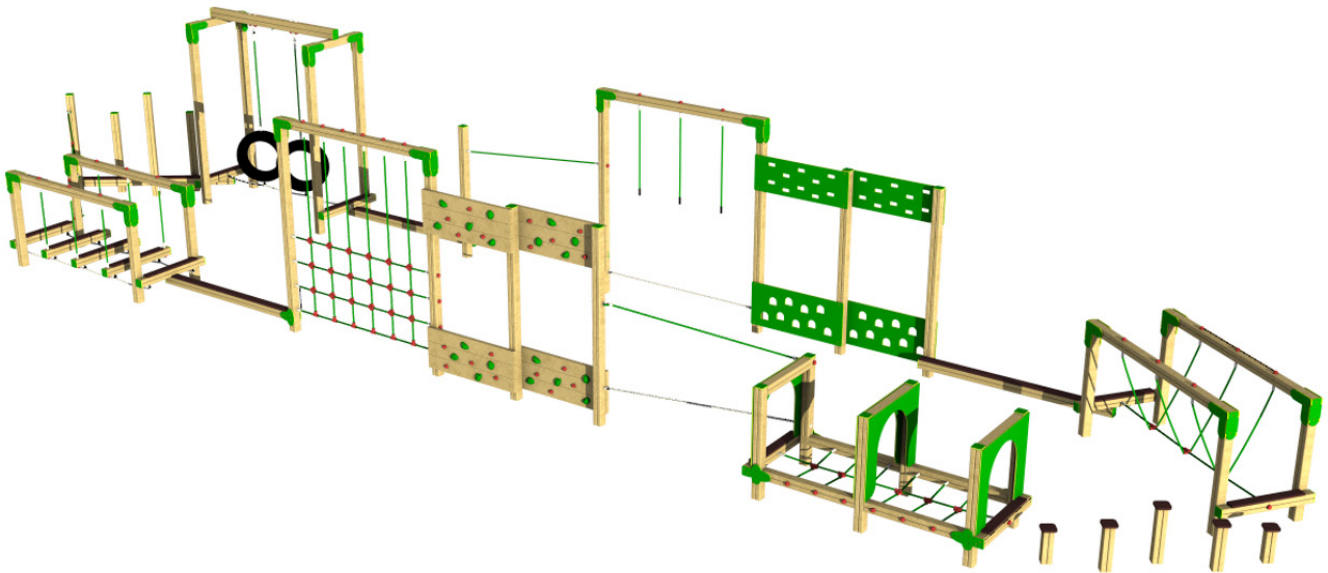

Scramble Net/ Double Timber Climbing Wall/ Parallel Rope Walk (x2)/ Arch Net Tunnel/ Stepping Logs/ Rope Bridge/ Balance Beam (x3)/ Double Climbing Wall/ Rope Walk/ Beam Crossing/ Tyre Crossing Weaving Beam/ Log Walk

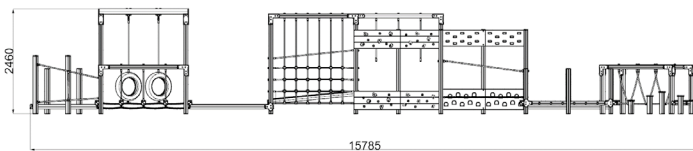
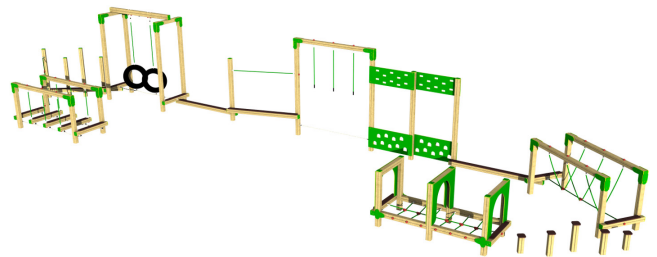
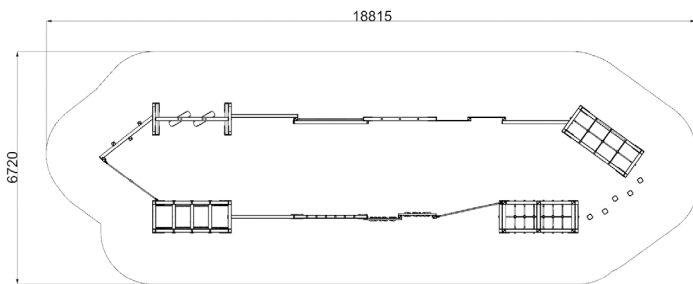

Free Fall Height: 1.00m
Space Required: 18.90m x 6.80m
Minimum Surfacing Area: 113m²

 **MADE IN
BRITAIN**

creative
play

Design your perfect playground

Please Print to actual size (A3)

creative
play

Design your play equipment

Please Print to actual size (A3)