

# Calculating angles on a straight line

1 Work out the sizes of the unknown angles.

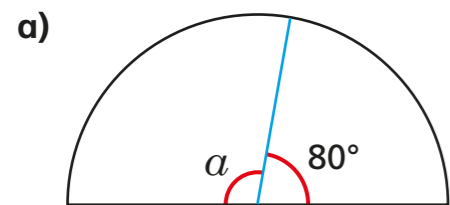

$a = \boxed{\phantom{000}}^\circ$

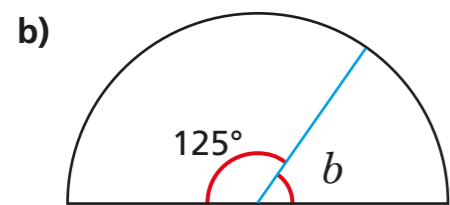

$b = \boxed{\phantom{000}}^\circ$

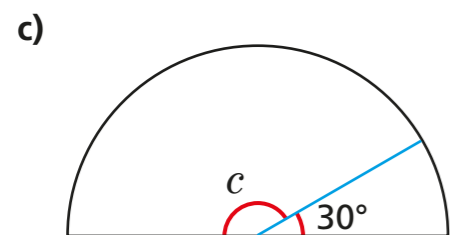

$c = \boxed{\phantom{000}}^\circ$

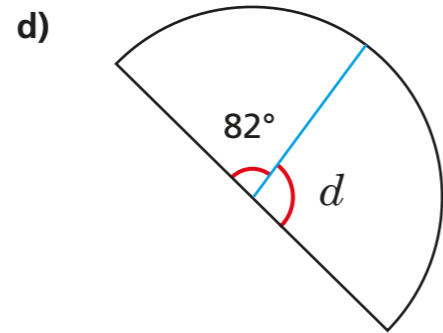

$d = \boxed{\phantom{000}}^\circ$

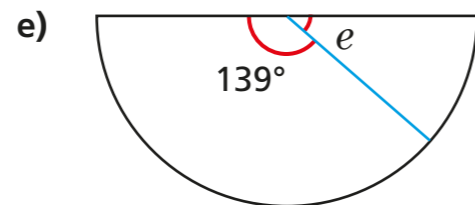

$e = \boxed{\phantom{000}}^\circ$

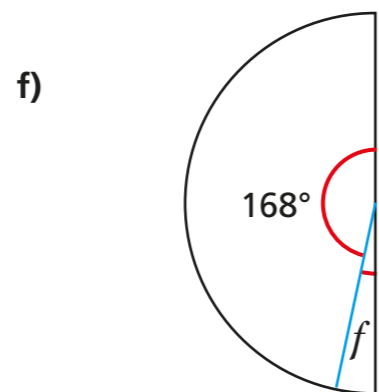

$f = \boxed{\phantom{000}}^\circ$

2 Work out the size of the unknown angles.

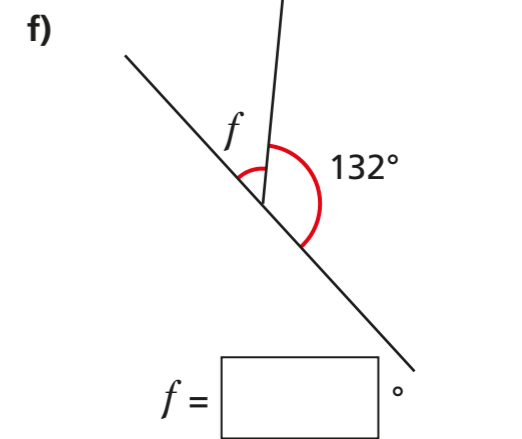
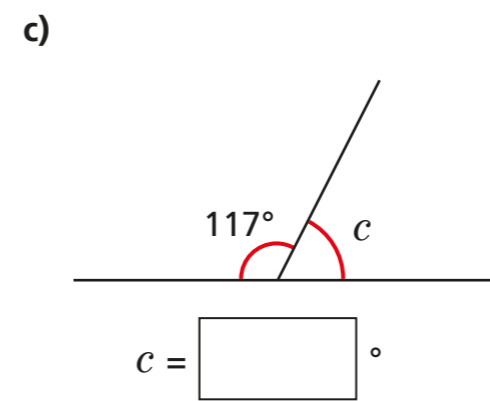
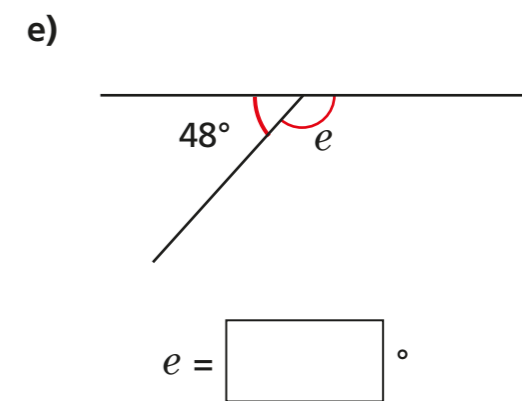
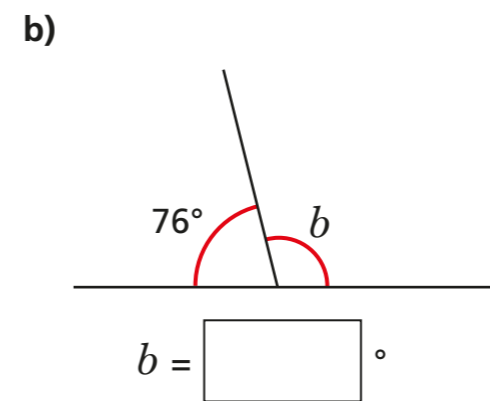
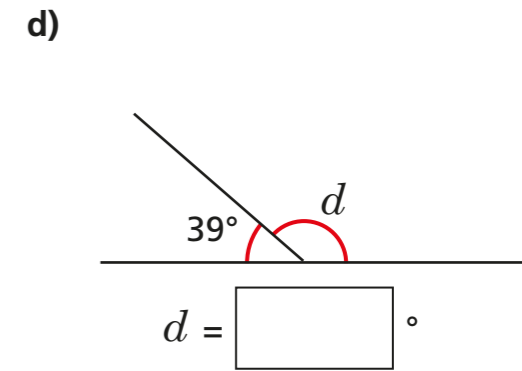
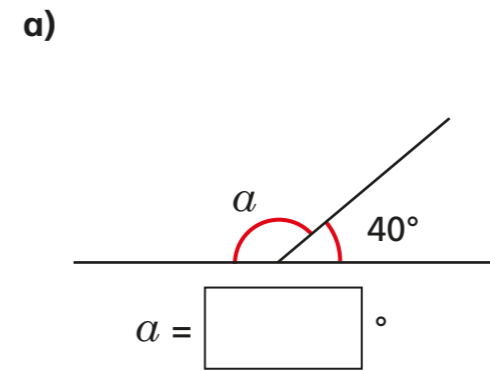

3 Dora draws two angles.

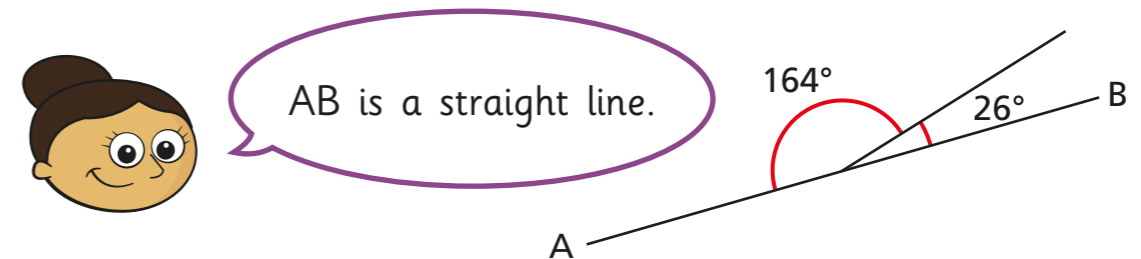

Do you agree with Dora? \_\_\_\_\_

Explain your answer.



4 Work out the size of the unknown angles.

Show the steps in your working.

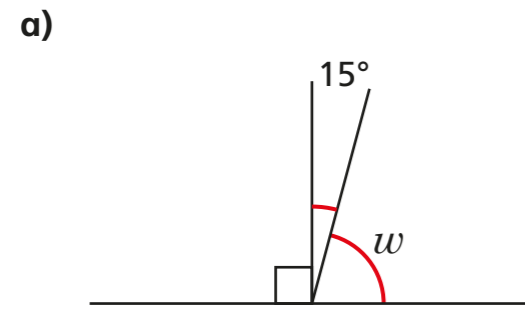

$$w = \boxed{\phantom{00}}^\circ$$

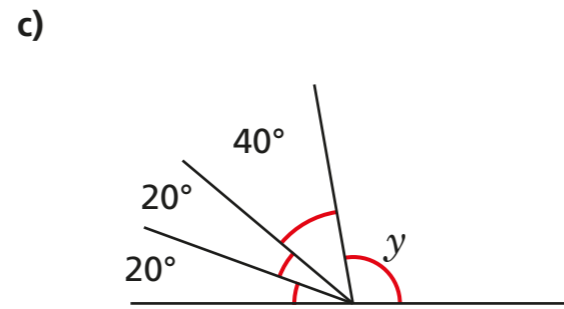

$$y = \boxed{\phantom{00}}^\circ$$

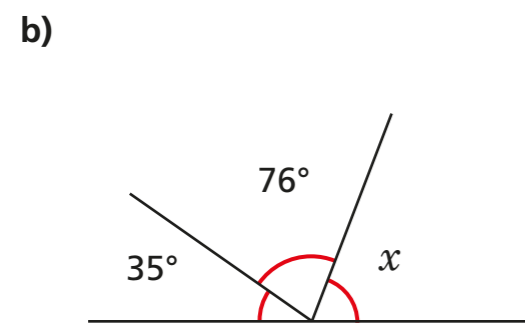

$$x = \boxed{\phantom{00}}^\circ$$

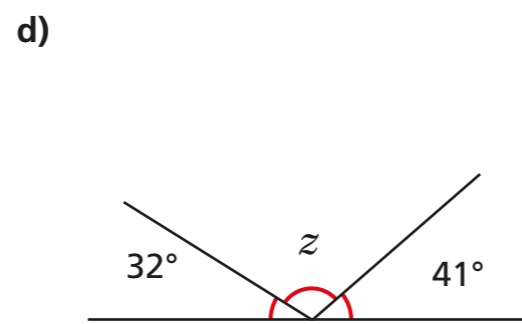

$$z = \boxed{\phantom{00}}^\circ$$

5 Work out the sizes of the unknown angles.

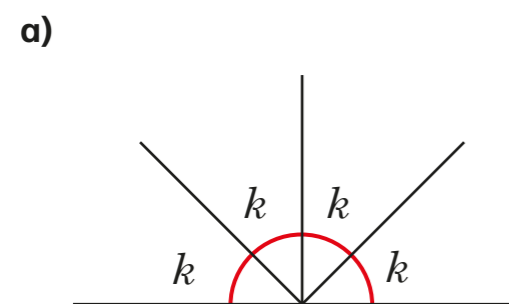

$$k = \boxed{\phantom{00}}^\circ$$

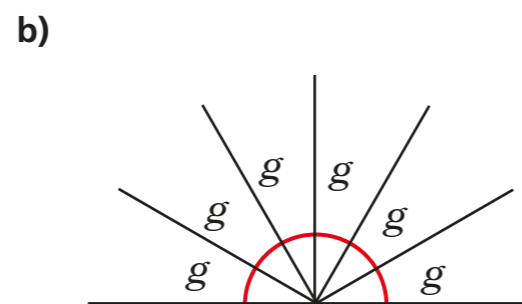

$$g = \boxed{\phantom{00}}^\circ$$

6 Work out the size of angle  $a$ .

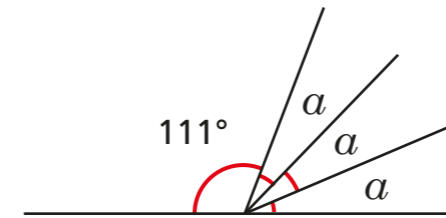

$$a = \boxed{\phantom{00}}^\circ$$

7 Work out the size of angle  $m$ .

Show all your working out.

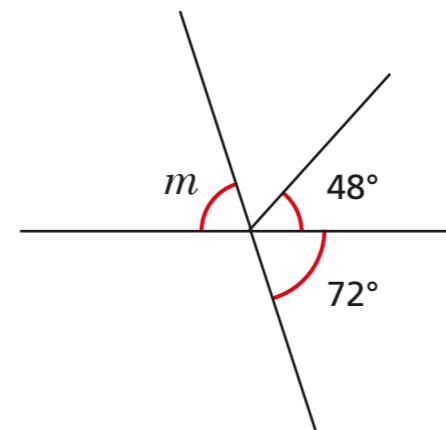

$$m = \boxed{\phantom{00}}^\circ$$

8 Two angles are marked.

Angle  $b$  is eight times the size of angle  $a$ .

What is the size of each angle?

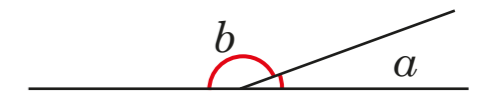

$$a = \boxed{\phantom{00}}^\circ \quad b = \boxed{\phantom{00}}^\circ$$