



'Loving God in all we do'

MENTAL CALCULATION POLICY FOR ADDITION AND SUBTRACTION

This policy details the progression towards mental calculation strategies for addition and subtraction.

The ability to calculate mentally is an essential skill, but, as with written methods of calculation, children need to be taught. **It is important to ensure that when teaching particular strategies, children have the appropriate prerequisite skills and are guided as to how and when that strategy is appropriate.**

Children should be taught and encouraged to ask themselves the following questions when faced with a calculation:

- Do I know the answer?
- Can I work it out in my head?
- Do I need to do a jotting?
- Do I need to use a written method?

When using a jotting, there is no requirement to follow a particular method of recording.

A feature of mental calculation is that a type of calculation can often be worked out in several different ways. Which method is best will depend on the numbers involved, the age of the children and the range of methods that they are confident with.

In developing a progression through mental calculation strategies for addition and subtraction, it is important that children understand the relevant concepts, in that addition is:

- combining two or more groups to give a total or sum
- increasing an amount

and subtraction is:

- removal of an amount from a larger group (take away)
- comparison of two amounts (difference)

They also need to understand and work with certain principles, that:

- addition and subtraction are inverses
- addition is commutative i.e. $5 + 3 = 3 + 5$ but subtraction is not $5 - 3$ is not the same as $3 - 5$
- addition is associative i.e. $5 + 3 + 7 = 5 + (3 + 7)$ but subtraction is not $10 - 3 - 2$ is not the same as $10 - (3 - 2)$

Commutativity and associativity mean that calculations can be rearranged, e.g. $4 + 13 = 17$ is the same as $13 + 4 = 17$.

Early Learning Goal:

Using quantities and objects, children add and subtract two single digit numbers and count on or back to find the answer.

In the EYFS, children are encouraged to develop a mental picture of the number system in their heads to use for calculation. They should experience practical calculation opportunities using a wide variety of practical equipment, including small world play, role play, counters, cubes etc.

To solve addition and subtraction problems, they may know familiar calculations such as $5 + 5$ or $10 - 1$, but for other calculations, they may use either a counting all or counting on strategy for addition and a taking away strategy for subtraction. They will subtract by using practical equipment to count out the first number and then remove or take away the second number to find the solution by counting how many are left.

Counting forwards is the preferable strategy at this stage as counting back requires an abstract understanding of the number system.

End of Year Objective:

Add and subtract one-digit and two-digit numbers to 20, including zero.

Rapid Recall

Children should be able to:

- represent and use number bonds and related subtraction facts within 20

Number bonds can be represented practically using:

Double sided counters:

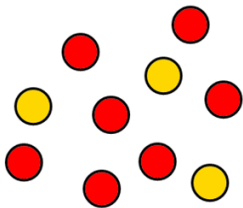

Ten frames:

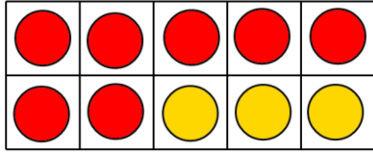

Beadstrings

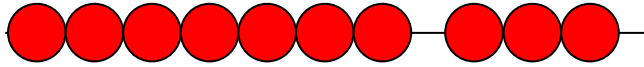

Mental Strategies

Count on or back in ones (chain count and linked to objects, i.e. 1-1 correspondence)

Initially, children's counting for addition and subtraction should be linked to the objects that they are using to represent the calculation, e.g. cubes, counters etc. It is important that at this stage the counting and calculating are supported by practical equipment and/or be in context so that they support children's developing understanding of the concepts of addition and subtraction in a concrete rather than abstract way.

Children can begin to use chain counting (i.e. unsupported by objects) when they are confident with the concepts of addition and subtraction and have developed their understanding of using counting on or back, rather than counting all, as a strategy for these calculations.

Examples of calculations:

- | | |
|----------|---|
| $4 + 5$ | count on in ones from 4 (or in ones from 5) |
| $8 - 3$ | count back in ones from 8 |
| $10 + 7$ | count on in ones from 10 (or use place value) |
| $13 + 5$ | count on in ones from 13 |
| $17 - 3$ | count back in ones from 17 |

Prerequisite skills:

- Count using one to one correspondence
- Count forwards and backwards in ones

To develop an understanding of addition and subtraction, the progression through learning should be:

Concrete → Model → Abstract

An example of this might be:

Using counters (Concrete – random) → Using a beadstring (Concrete – organised) → Placing cubes on a number track (Model) → numberline (Abstract)

Addition

$3 + 2 = 5$

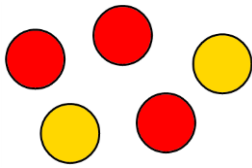

Counters

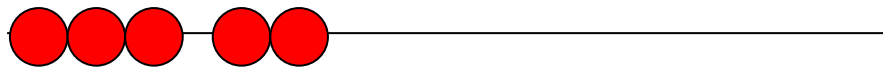

Beadstring

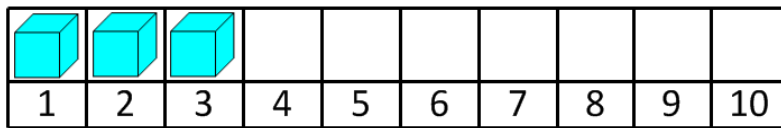

Number track

stage 1

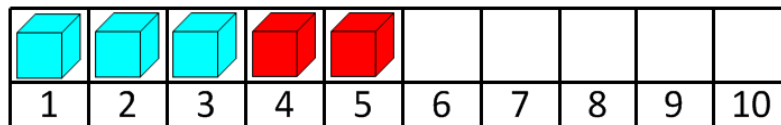

Number track

stage 2

$3 + 2 = 5$

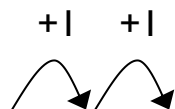

Numberline

0 1 2 3 4 5 6 7 8 9

Subtraction

$$5 - 2 = 3$$

Touch count and remove the number to be taken away, in this case 2.



Counters stage

1

Touch count to find the number that remains.



Counters stage

2

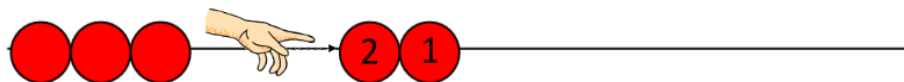





Beadstring

stage 1



Beadstring

stage 2

									
1	2	3	4	5	6	7	8	9	10

Number track

stage 1

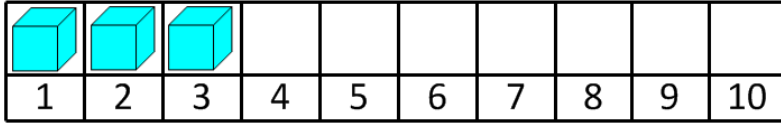

Number track

stage 2

$$5 - 2 = 3$$

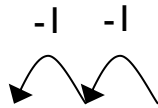

Numberline

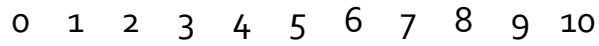

Addition

$$8 + 5 = 13$$

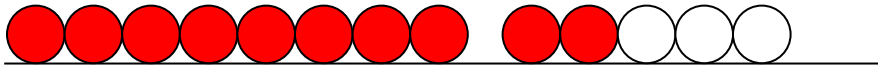

Beadstring

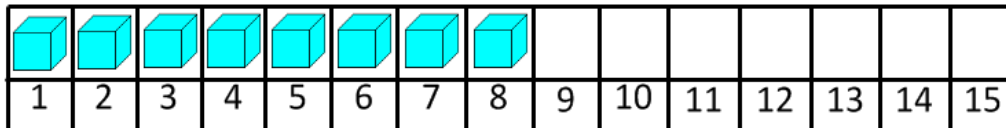

Number track

stage 1

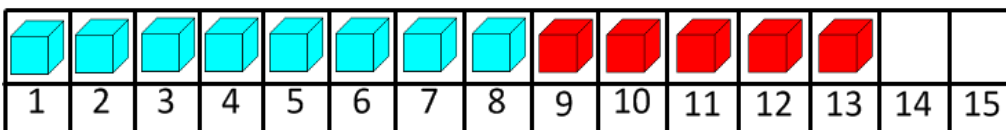

Number track

stage 2

$$8 + 5 = 13$$

+| +| +| +| +|

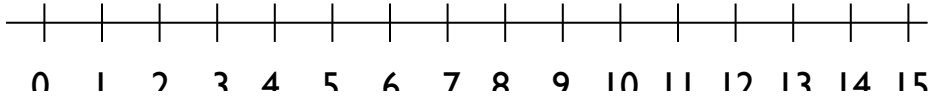

Numberline

Subtraction

$$13 - 5 = 8$$

Touch count and remove the number to be taken away, in this case 5.

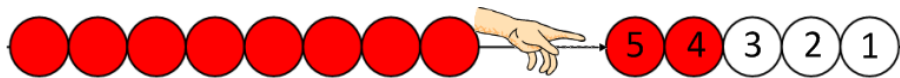

stage 1

Beadstring

Touch count to find the number that remains.

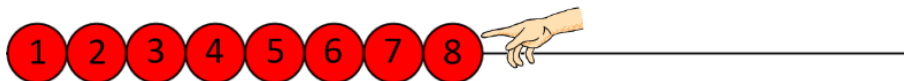

stage 2

Beadstring

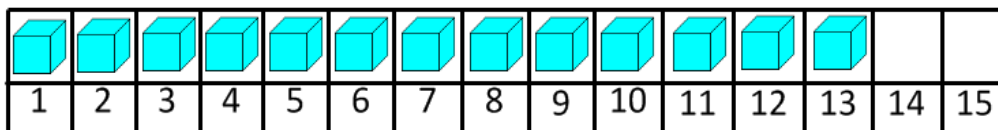

stage 1

Number track

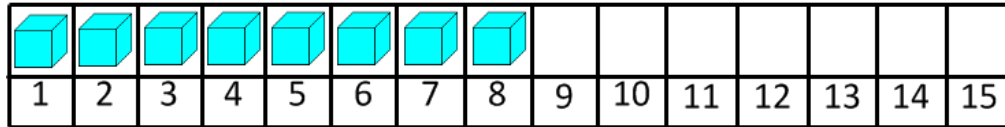

Numbertrack

stage 2

$$13 - 5 = 8$$

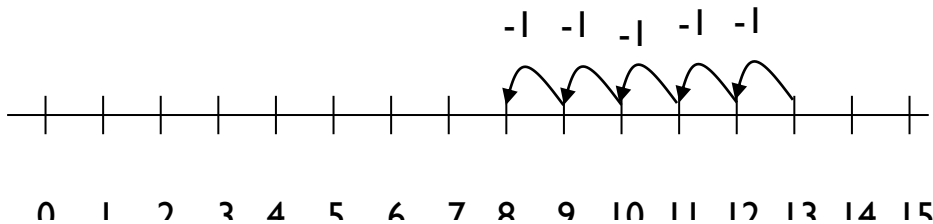

Numberline

Reorder numbers in a calculation

In Y1, children need to recognise that they can rearrange an addition, but not a subtraction. They also need to understand that the principle behind reordering a calculation is to make it more efficient, particularly when utilising a counting on strategy. Children need to be encouraged to identify calculations which should be reordered and those that are already in the most efficient format.

Examples of calculations:

- 8 + 3 doesn't need reordering as the greater number is first already
- 2 + 7 reorder as 7 + 2
- 5 + 13 reorder as 13 + 5
- 11 + 6 doesn't need reordering as the greater number is first already

Prerequisite skills:

- Understand the place value of numbers to identify which number is the greater
- Understand that reordering works (at this stage) for addition but not subtraction* (*because children are not at the level when they are solving calculations such as 16 - 3 - 6, when reordering would be appropriate*).

Partition small numbers, e.g. $8 + 3 = 8 + 2 + 1$

Utilising partitioning in this way is useful as a strategy for bridging across 10 or multiples of 10 to make calculations more efficient.

Examples of calculations:

$7 + 5$ partitioned as $7 + 3 + 2$

$9 + 7$ partitioned as $9 + 1 + 6$

$6 + 8$ partitioned as $6 + 4 + 4$

Prerequisite skills:

- Partition numbers in different ways, e.g. 5 as 2 + 3 to enable $8 + 5$ as $8 + 2 + 3$
- Know, or quickly derive, number bonds for numbers up to and including 10
-

This method can be supported by the use of practical equipment, e.g.

Addition

$8 + 3 = 11$

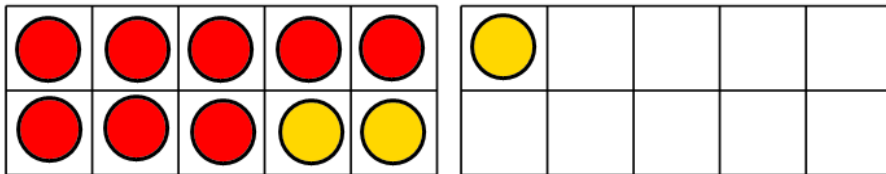

Ten frame

$8 + 3 = 11$

3 partitions into 2 and 1

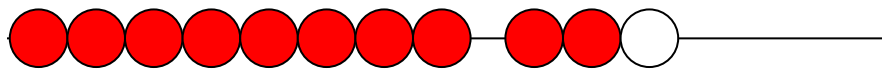

Beadstring

$8 + 3 = 11$

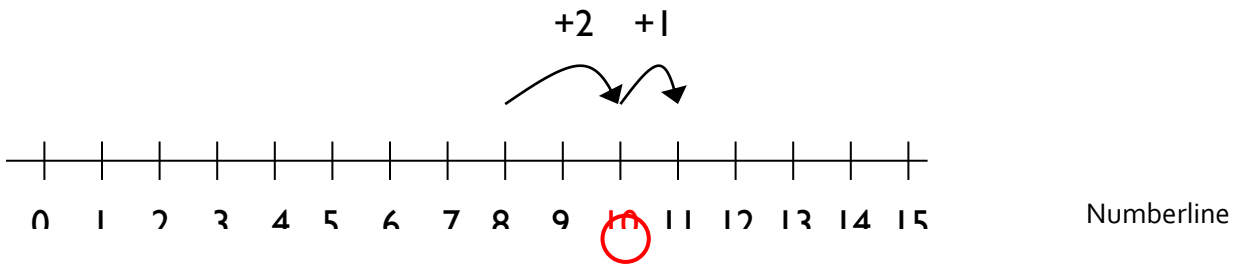

Subtraction

$11 - 3 = 8$

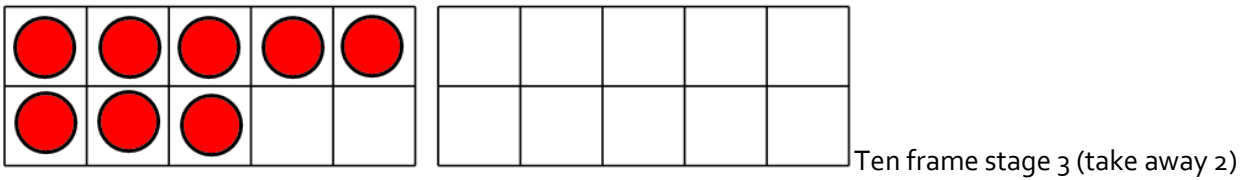
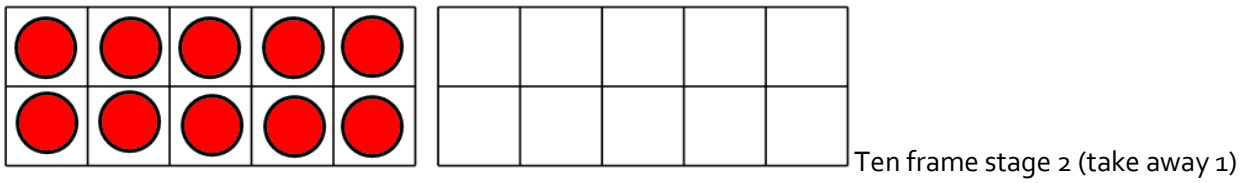
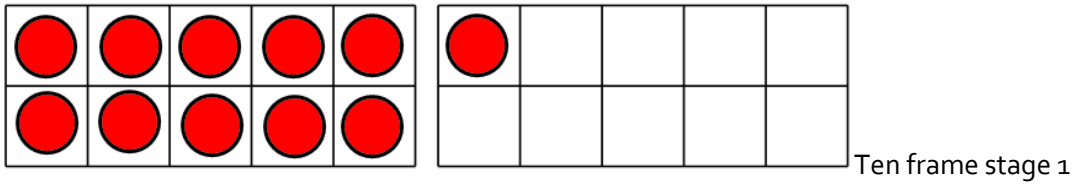

$11 - 3 = 8$

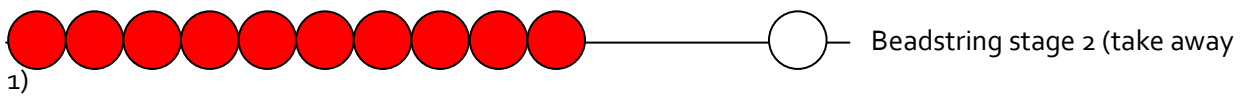
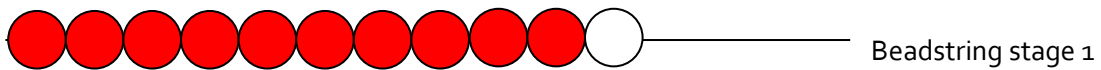

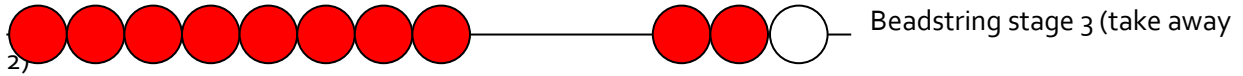

$$11 - 3 = 8$$

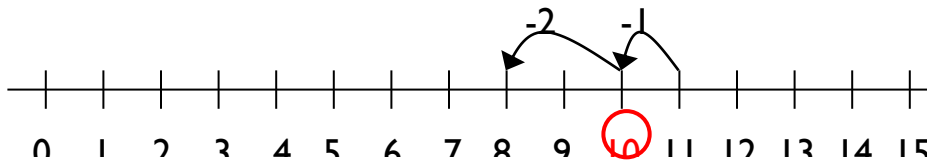

Y2

End of Year Objective:

Add and subtract numbers mentally, including: a two-digit number and ones; a two-digit number and tens; two two-digit numbers; three one-digit numbers.

Rapid Recall

Children should be able to:

- recall and use addition and subtraction facts to 20 fluently
- derive and use related facts up to 100

Beadstrings are useful for deriving and using related facts up to 100.

$$60 + 40 = 100$$



Mental Strategies

Partition and combine multiples of tens and ones

Partitioning numbers is a core strategy for adding and subtracting pairs of numbers. Children can either partition both of the numbers in the calculation, or keep the first number the same and just partition the second. They should be encouraged to use mental methods when adding or subtracting:

- multiples of 10
- TU + or – U (not crossing tens boundaries)
- TU + or – TU (not crossing tens boundaries)

Examples of calculations

$$40 + 37 \quad 40 \text{ add } 30 \text{ and } 7 = 40 \text{ add } 30 \text{ add } 7$$

$$15 + 14 \quad 10 \text{ and } 5 \text{ add } 10 \text{ and } 4 = 10 \text{ add } 10 \text{ add } 5 \text{ add } 4 \text{ or } 15 \text{ add } 10 \text{ add } 4$$

$$37 + 12 \quad 37 \text{ add } 10 \text{ and } 2 = 37 \text{ add } 10 \text{ add } 2$$

$$78 - 42 \quad 78 \text{ take away } 40 \text{ and } 2 = 78 \text{ take away } 40 \text{ take away } 2$$

$$80 - 35 \quad 80 \text{ take away } 30 \text{ and } 5 = 80 \text{ take away } 30 \text{ take away } 5$$

Prerequisite skills:

- Count using one to one correspondence
- Count forwards and backwards in ones and tens from any one- or two-digit number
- Understand place value, understand which digit represents tens and which digit represents ones and identify what changes if one is added or subtracted, and what changes if ten is added or subtracted.
- Partition numbers into tens and ones

Addition

$34 + 3 = 37$ (shown using Base 10 equipment)

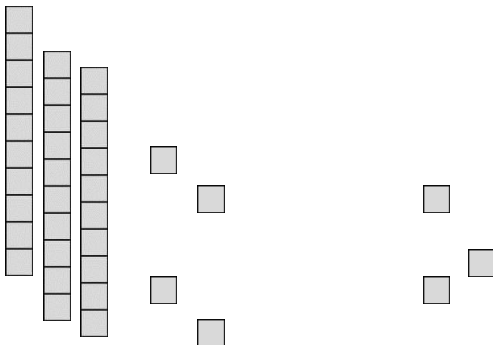

$34 + 3 = 37$ (shown using a beadstring)

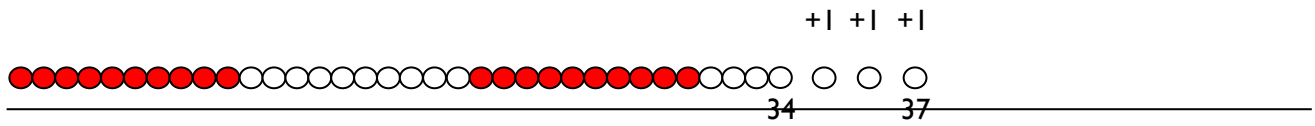

$34 + 3 = 37$ (shown using a numberline)

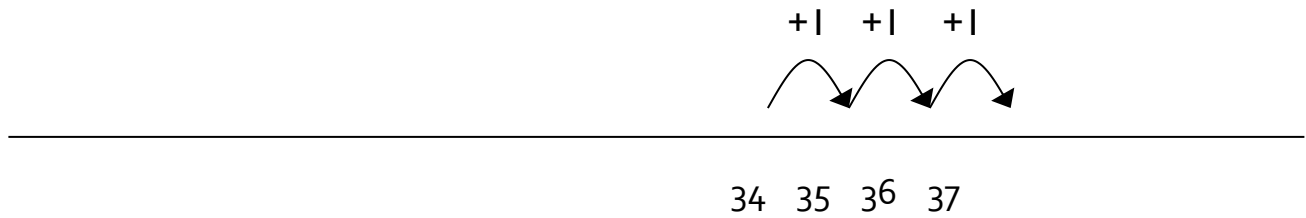

$34 + 20 = 54$ (shown using Base 10 equipment)

Children could use Base 10 equipment to calculate this as:

$$30 + 20 = 50$$

$$50 + 4 = 54$$

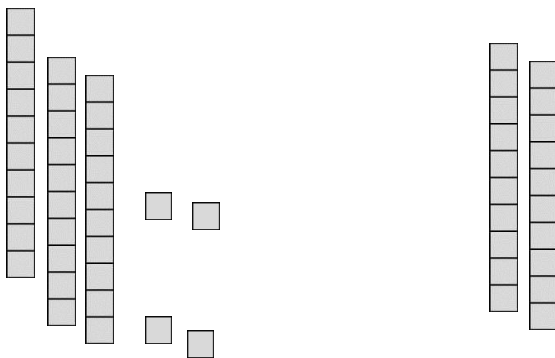

$34 + 20 = 54$ (shown using a beadstring)

Children could use a beadstring to calculate this as:

$$34 + 10 = 44$$

$$44 + 10 = 54$$

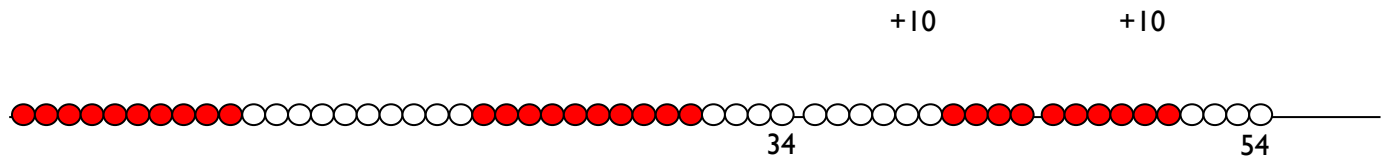

$34 + 20 = 54$ (shown using a numberline)

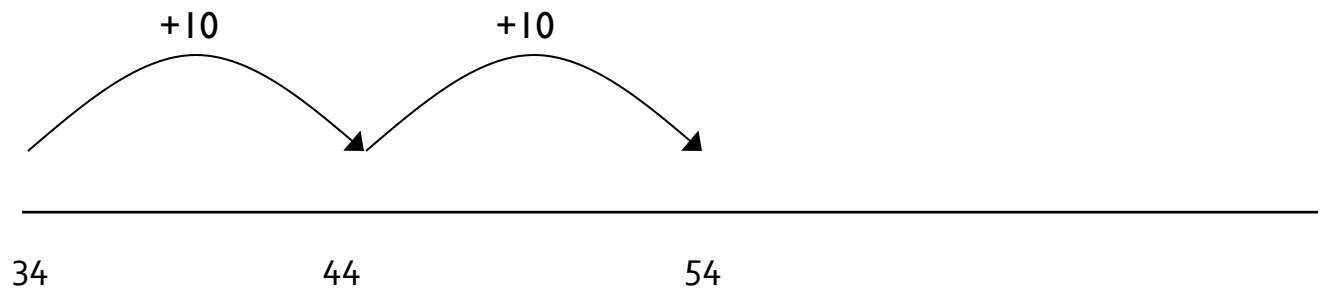

$34 + 23 = 57$ (shown using Base 10 equipment to partition both numbers)

Children could use Base 10 equipment to calculate this as:

$30 + 20 = 50$

$4 + 3 = 7$

$50 + 7 = 57$

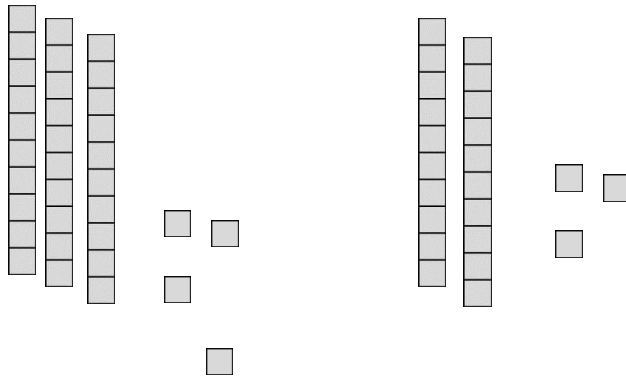

$34 + 23 = 57$ (shown using a beadstring to keep the first number the same and just partition the second)

Children could use a beadstring to calculate this as:

$34 + 10 = 44$

$44 + 10 = 54$

$54 + 3 = 57$

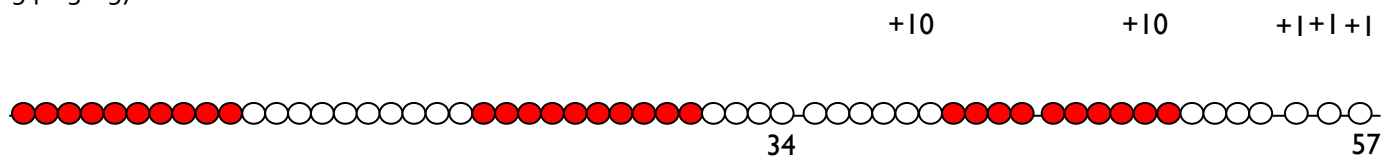

$34 + 23 = 57$ (shown using a numberline to keep the first number the same and just partition the second)

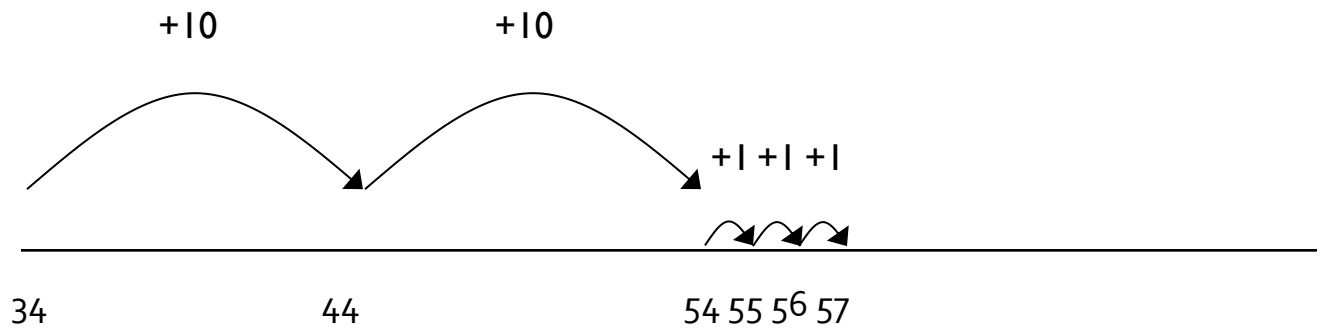

Encourage children to become more efficient by adding the units in one jump (by using the known fact $4 + 3 = 7$).

$$34 + 23 = 57$$

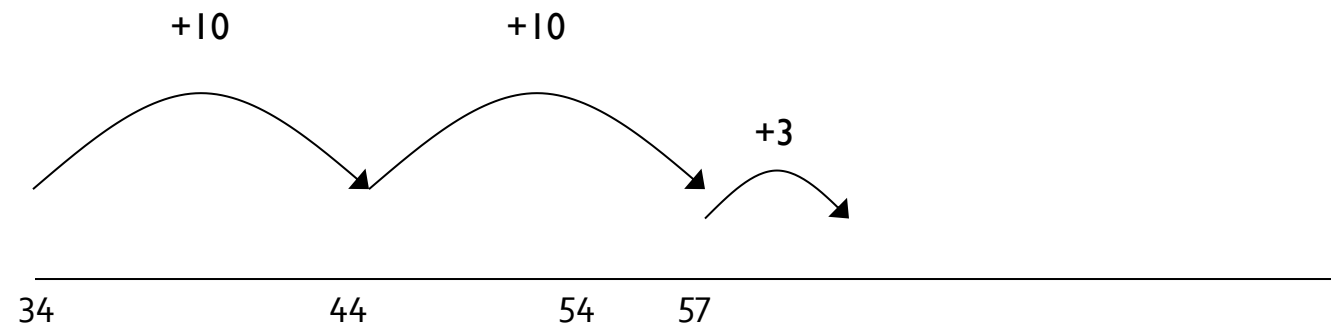

Followed by adding the tens in one jump and the units in one jump.

$$34 + 23 = 57$$

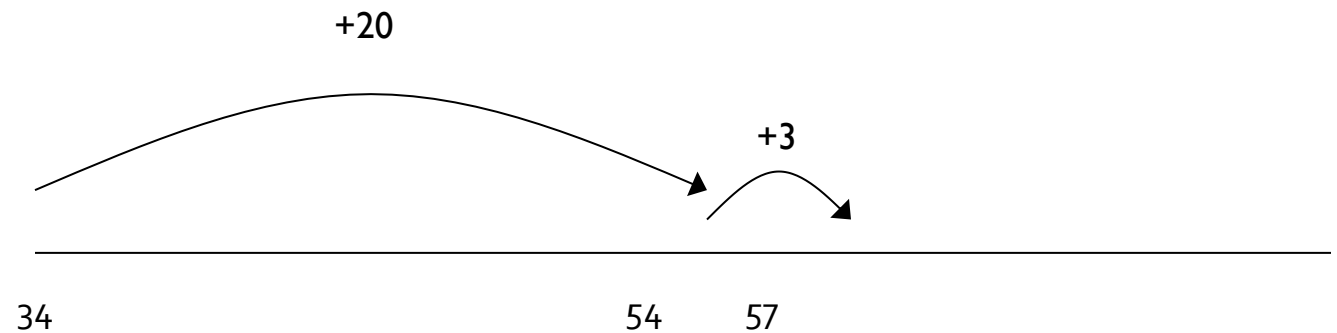

Subtraction

$47 - 3 = 44$ (shown using Base 10 equipment)

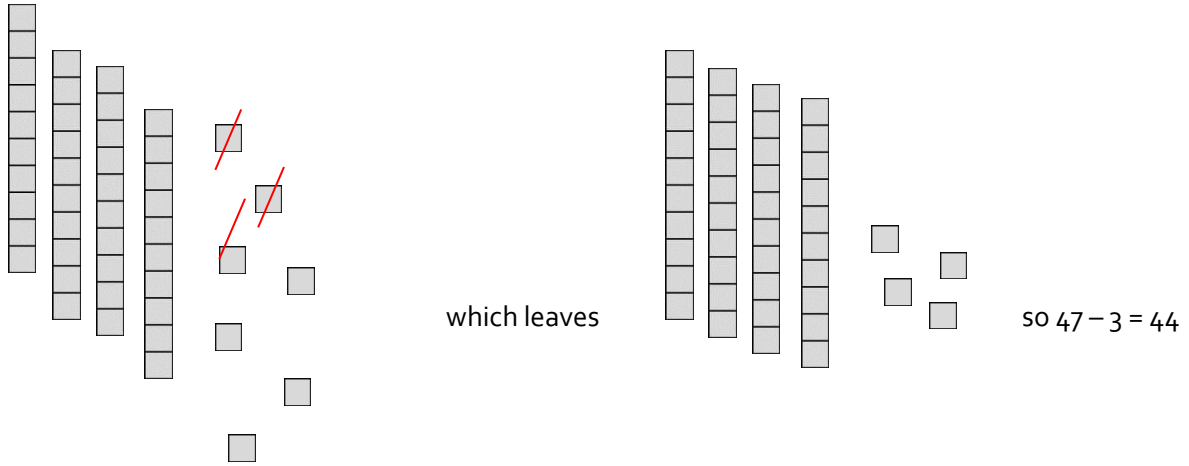

$47 - 3 = 44$ (shown using a beadstring)

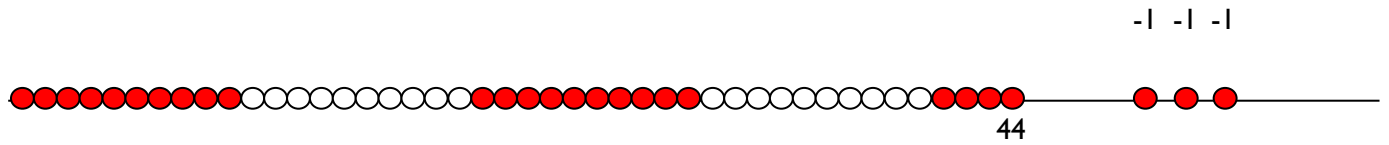

$47 - 3 = 44$ (shown using a numberline)



$47 - 20 = 27$ (shown using Base 10 equipment)

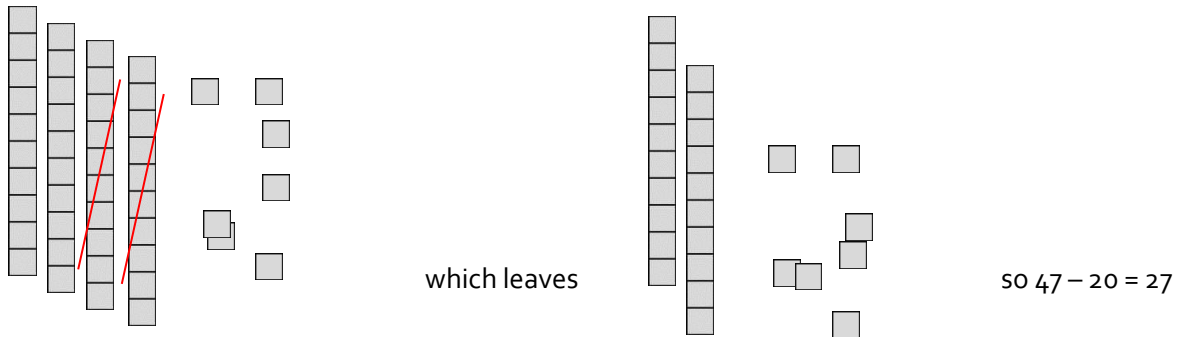

$47 - 20 = 27$ (shown using a beadstring)

Children could use a beadstring to calculate this as:

$$47 - 10 = 37$$

$$37 - 10 = 27$$

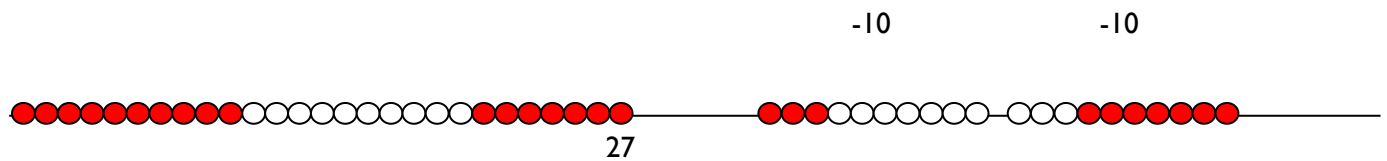

$47 - 20 = 27$ (shown using a numberline)

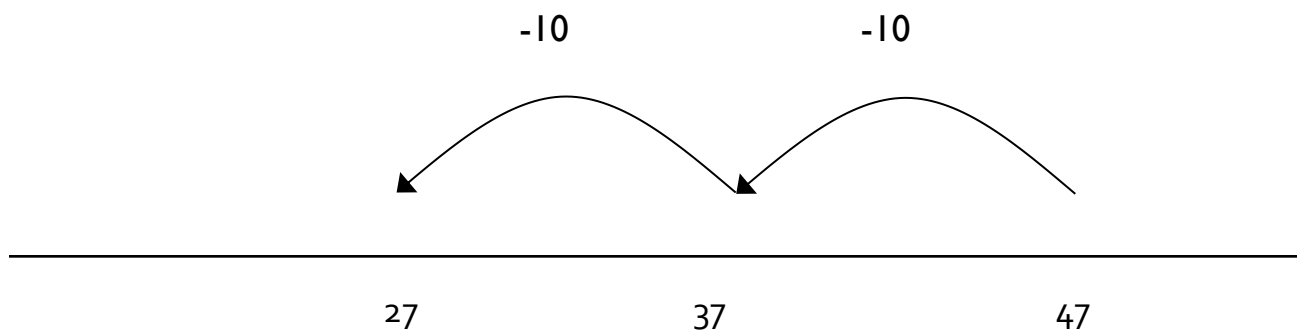

$47 - 23 = 24$ (shown using Base 10 equipment)

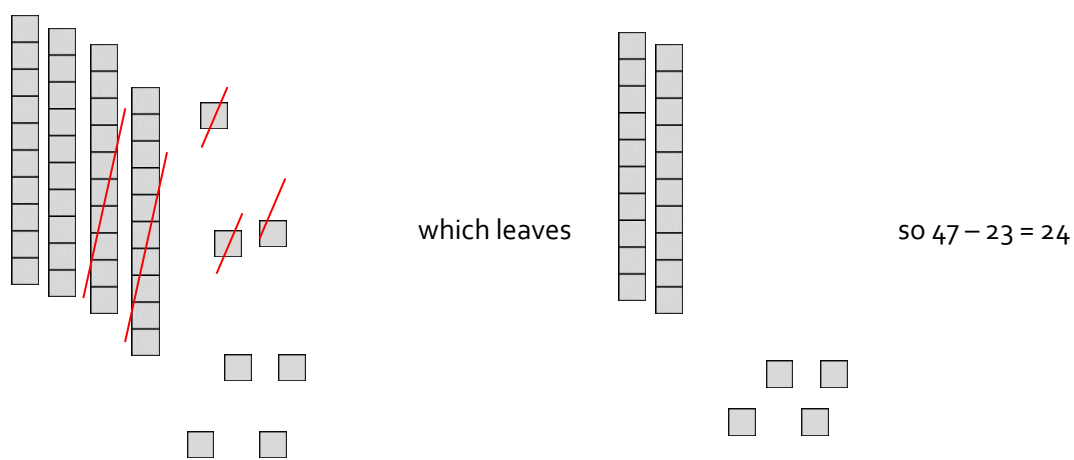

$47 - 23 = 24$ (shown using a beadstring)

Children could use a beadstring to calculate this as:

$$47 - 10 = 37$$

$$37 - 10 = 27$$

$$27 - 3 = 24$$

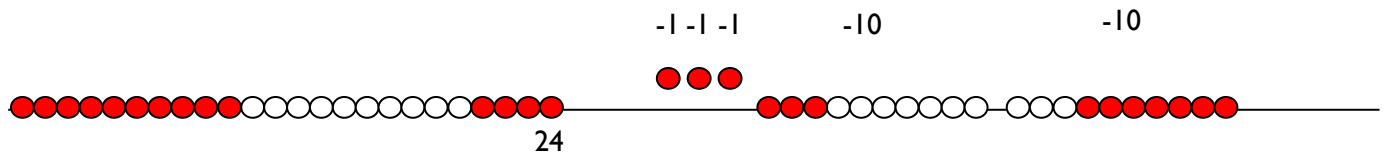

$47 - 23 = 24$ (shown using a numberline)

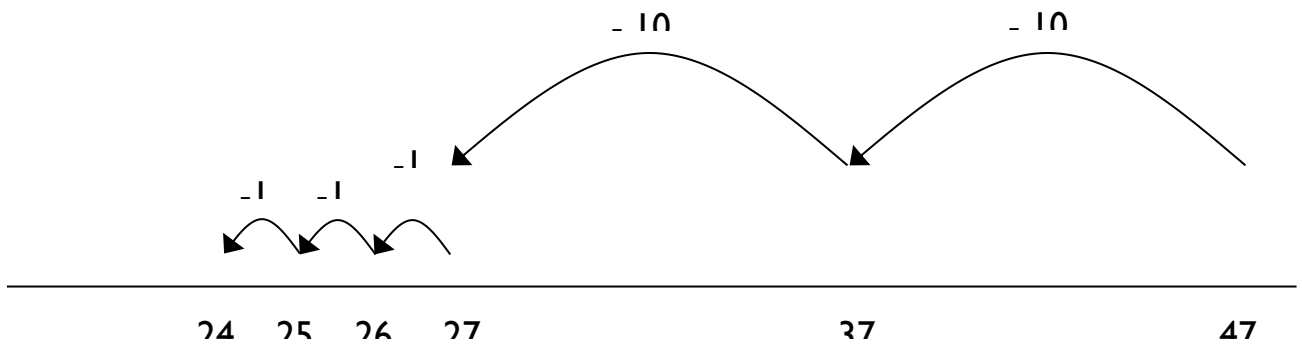

Encourage children to become more efficient by subtracting the units in one jump (by using the known fact $7 - 3 = 4$).

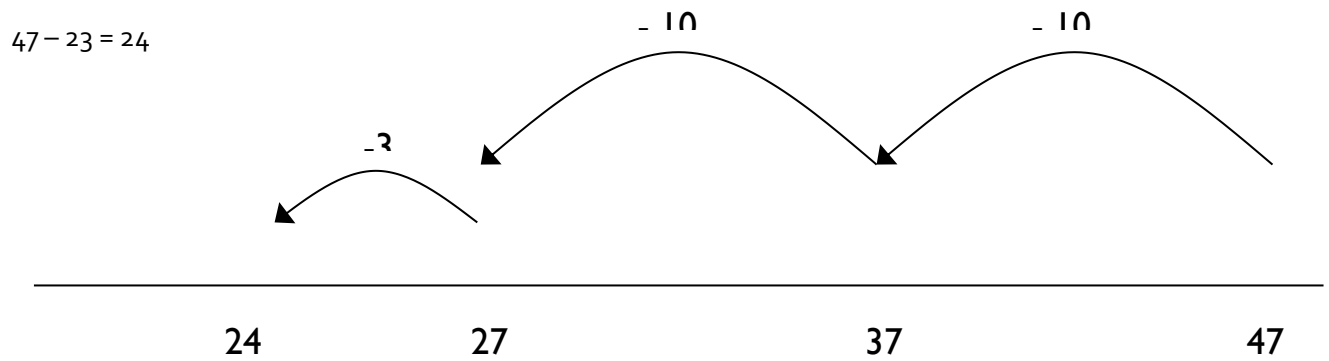

Followed by subtracting the tens in one jump and the units in one jump.

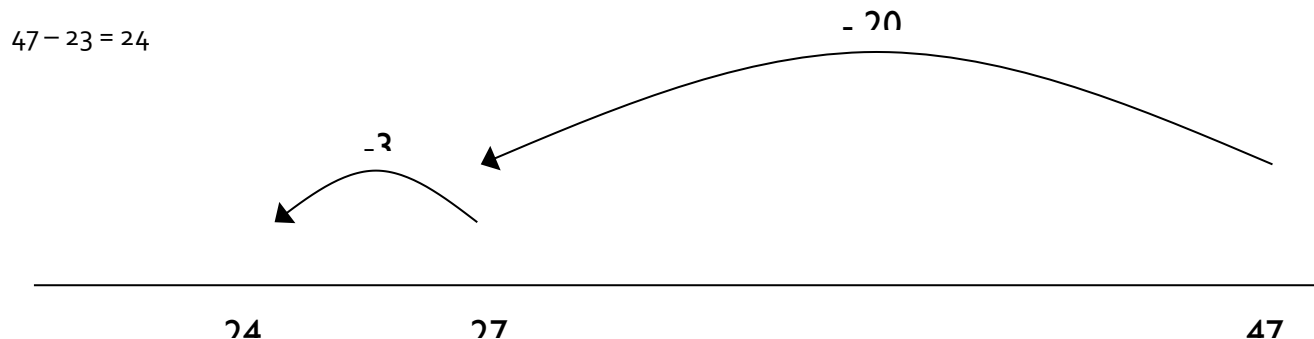

Reorder numbers in a calculation

In Y2, children need to recognise that they can rearrange an addition, but not a subtraction. They also need to understand that the principle behind reordering a calculation is to make it more efficient, particularly when utilising a counting on strategy. Children need to be encouraged to identify calculations which should be reordered and those that are already in the most efficient format. When adding three single digit numbers, reordering should be based on number bonds or doubles with which the child is familiar.

Examples of calculations:

$$5 + 34$$

$$34 + 5$$

$$42 + 11$$

doesn't need reordering as the greater number is first already

$$5 + 7 + 55 + 5 + 7 \text{ (utilising knowledge of number bonds or doubles)}$$

Prerequisite skills:

- Understand the place value of numbers to identify which number is the greater
- Understand that reordering works for addition but not subtraction* (*because children are not at the level when they are solving calculations such as $16 - 3 - 6$, when reordering would be appropriate*).

Find a small difference by counting up from the lesser to the greater number

Children should, using their knowledge of place value, be able to identify when numbers are close together. When that is the case, it is more efficient, when subtracting, to count on to find the difference, rather than taking away. For example, in the calculation $52 - 47$, to solve this by:

$$52 - 47 = 5$$

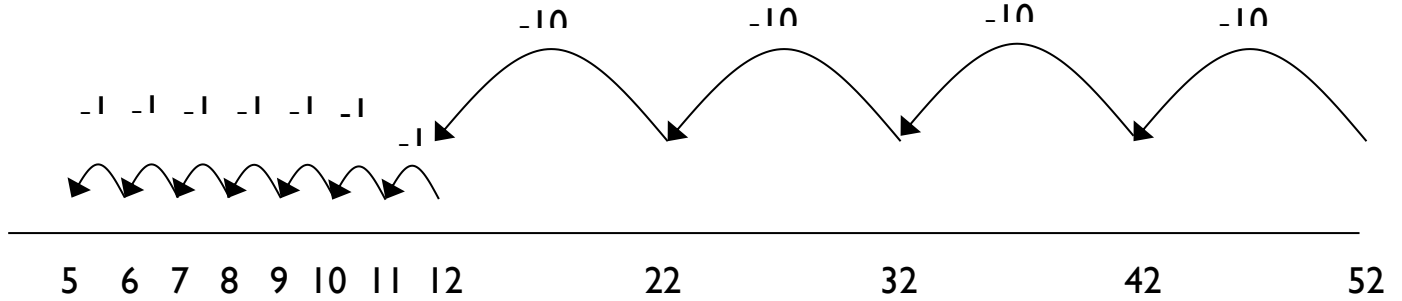

is far less efficient than:

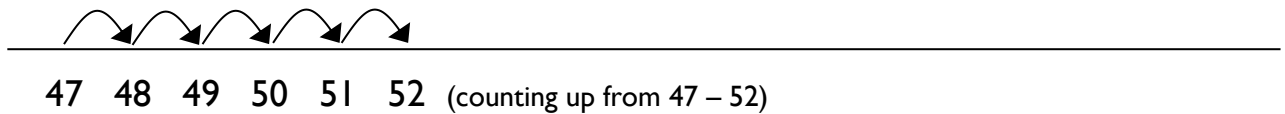

For children to use this method with understanding, it is important that they understand how counting on links to subtraction.

Initially, they should look at simple numbers to develop an understanding of the concept of difference and counting on. For example, with $7 - 4$, they can make two towers, one of 7 cubes and one of 4 cubes (Step 1). The calculation can be phrased as 'How many more do we need to make the towers the same size?' To answer this question, the children can add cubes of a different colour onto the smaller tower until they are the same height.

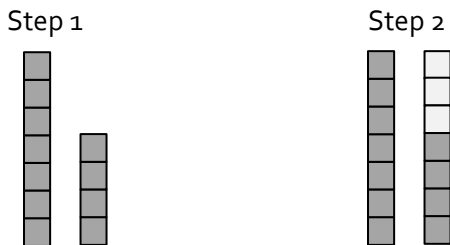

3 more cubes are needed to make them the same size, so the difference between 7 and 4 is 3. This could be compared to taking away 4 from 7 so that children can see that it is the same answer.

The next stage from this would be to encourage children to use the cubes to make lines rather than towers.



Once children can find the difference using this method using numbers up to 20, they can continue to use this strategy to solve calculations with two-digit numbers, using base 10 materials rather than cubes. For example, with the calculation $61 - 52$, children can use base 10 to set out two lines, one for each number (the base 10 in the illustration are two colours to enable tens to be identified, this does not need to be the case with the materials children are using).

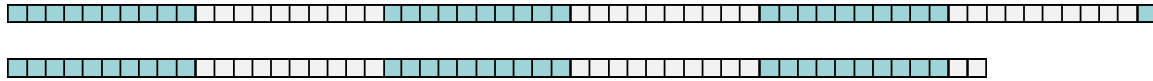

To find how many more are needed, or the difference, children would use a second colour of base ten ones to make the lines the same:



To make this a more sustainable method, it can be modelled alongside a number line jotting, e.g.

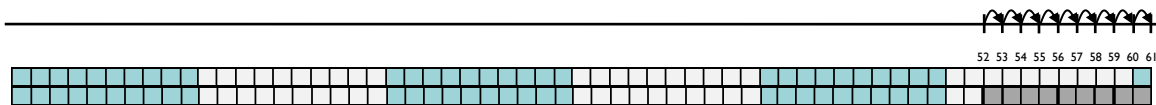

Examples of calculations

$$52 - 47$$

$$74 - 66$$

$$81 - 79$$

$$32 - 25$$

Prerequisite skills:

- Understand the place value of numbers to identify which number is the greater or lesser
- Place numbers on a partially marked and then unmarked number line
- Establish whether numbers are close together
- Count forwards and backwards in ones and tens form any one- or two-digit number

Begin to bridge through 10 when adding a single digit number (partitioning, e.g. $58 + 5 = 58 + 2 + 3$)

Use of the bridging strategy relies heavily on children's efficient and accurate recall of number bonds to 10 or how far away a number is from a multiple of 10 (see *use of 10 frames in Year 1*). When calculating, e.g. $48 + 5$, consider using bead strings or different coloured blocks of 10 cubes to illustrate it as $48 + 2 + 3$ using the natural colour demarcations in the bead string to support this identification. This can also be shown using 10 frames (see *Year 1 'Partition small numbers' section for more information*).

$$48 + 5 = 53$$

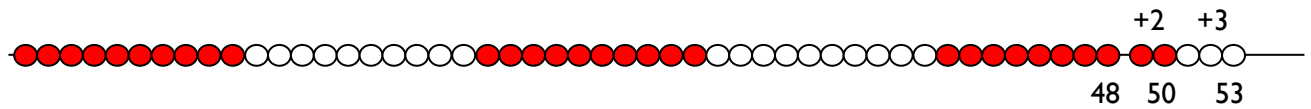

$$48 + 5 = 53$$



$$43 - 7 = 36$$

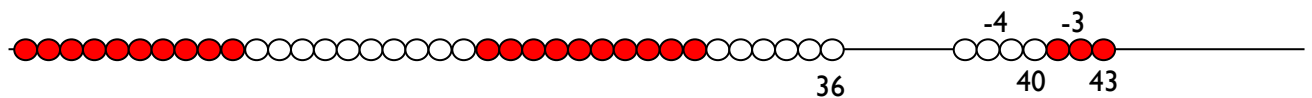

$$43 - 7 = 36$$

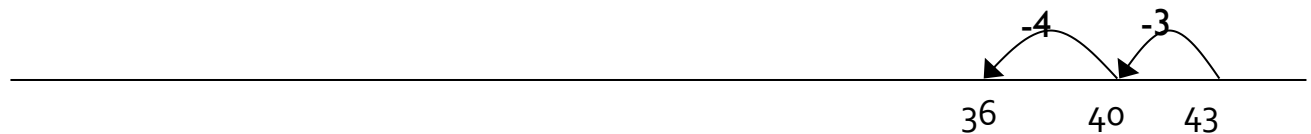

Examples of calculations

$$25 + 6 \quad \text{as } 25 + 5 + 1$$

$$12 - 7 \quad \text{as } 12 - 2 - 5$$

$$66 + 7 \quad \text{as } 66 + 4 + 3$$

$$43 - 7 \quad \text{as } 43 - 3 - 4$$

Prerequisite skills:

- Partition numbers in different ways, e.g. 5 as 2 + 3 to enable $58 + 5$ as $58 + 2 + 3$
- Know, or quickly derive, number bonds to 10

Add or subtract 9 and 19 by rounding and compensating

Children need to understand both the number system and number bonds in order to understand how to use a compensation method.

For adding 9, children should be shown how to add nine by using base 10 materials and then add ten to the same number to identify what would need to be adjusted to make the calculation correct, e.g. $23 + 9$

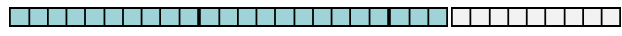
$$23 + 9$$

 $23 + 10$ is one too many, so I have to subtract one

NB Teaching children to add nine on a hundred square without developing their understanding will not support their ability to understand and use this method effectively.

Examples of calculations

$$34 + 9 \quad \text{as } 34 + 10 - 1$$

$$77 + 19 \quad \text{as } 77 + 20 - 1, \text{ or } 77 + 10 + 10 - 1$$

$$46 - 9 \quad \text{as } 46 - 10 + 1$$

$$63 - 19 \quad \text{as } 63 - 20 + 1, \text{ or } 63 - 10 - 10 + 1$$

Prerequisite skills:

- Understand the relationship between 9 and 10 (i.e. a difference of 1)
- Be able to show visually using base 10 equipment

Empty numberlines could be used to model the calculation.

Addition

$57 + 19 = 76$

+20

We've added twenty which is one too many, so we need to take one away.

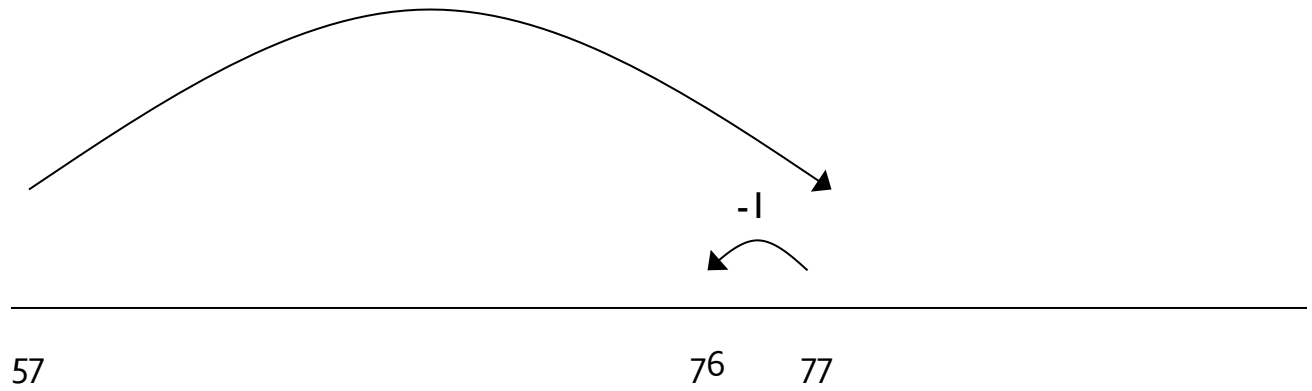

Subtraction

$46 - 9 = 37$

We've subtracted ten which is one too many, so we need to add one back.

-10

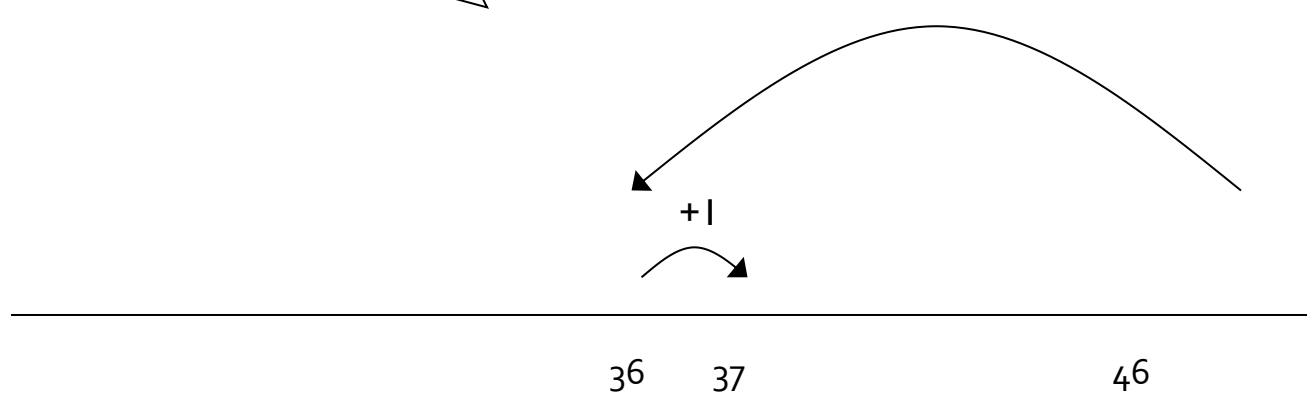

End of Year Objective:

Add and subtract numbers mentally, including: a three-digit number and ones; a three-digit number and tens; a three-digit number and hundreds.

Rapid Recall

Children should be able to:

- recall and use addition and subtraction facts for 100 (multiples of 5 and 10)
- derive and use addition and subtraction facts for 100
- derive and use addition and subtraction facts for multiples of 100 that total 1000

Mental Strategies***Partition and combine multiples of hundreds, tens and ones***

Partitioning numbers is a core strategy for adding and subtracting pairs of numbers. Children can either partition both of the numbers in the calculation, or keep the first number the same and just partition the second. *(See Y2 for more information).*

Examples of calculations:

$526 + 200$ counting on in hundreds

$137 + 40$ counting on in tens

$272 + 8$ counting on in ones

$428 - 200$ counting back in hundreds

$323 - 70$ counting back in tens

$693 - 8$ counting back in ones

$37 + 15$ 37 add 10 and 5 = 37 add 10 add 5 (crossing tens boundaries)

$42 - 25$ 42 take away 20 and 5 = 42 take away 20 take away 5 (crossing tens boundaries)

Prerequisite skills:

- Count forwards and backwards in ones, tens and hundreds from any one-, two- or three-digit number
- Understand place value and understand which digit changes if one, ten or hundred is added or subtracted
- Partition numbers into hundreds, tens and ones

Addition

$37 + 15 = 52$ (shown using a beadstring)

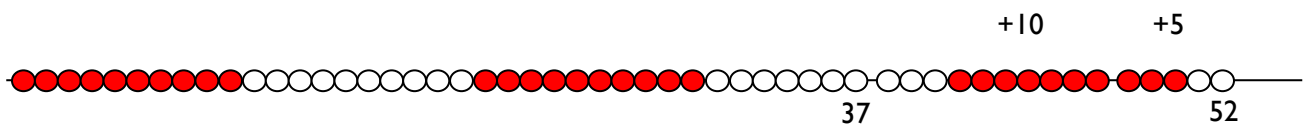

$37 + 15 = 52$ (shown using a numberline)

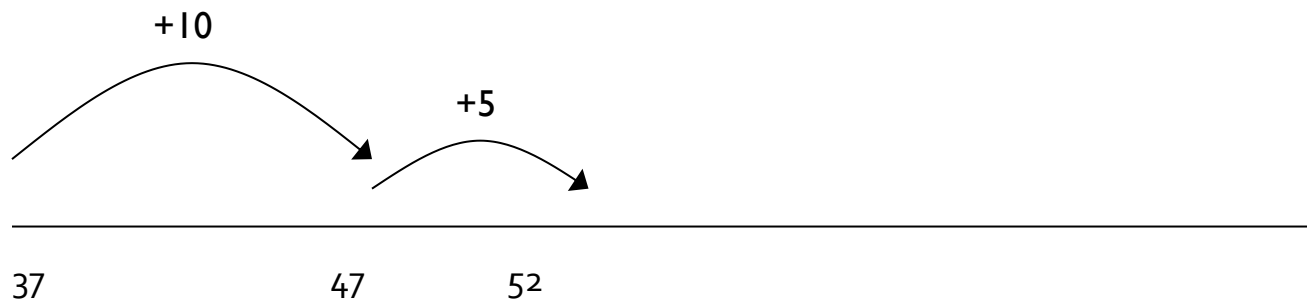

$37 + 15 =$ (shown using number sentences)

$$37 + 10 = 47$$

$$47 + 5 = 52$$

Subtraction

$42 - 25 = 17$ (shown using a beadstring)

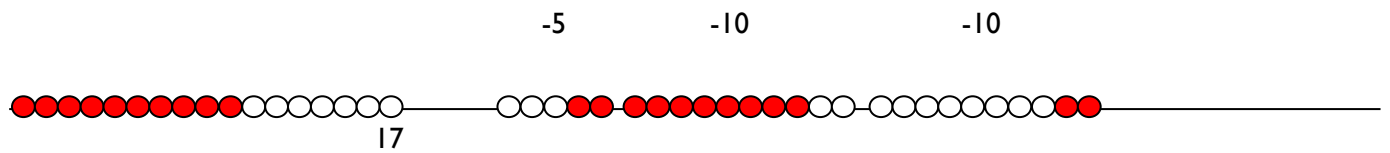

$42 - 25 = 17$ (shown using a numberline)

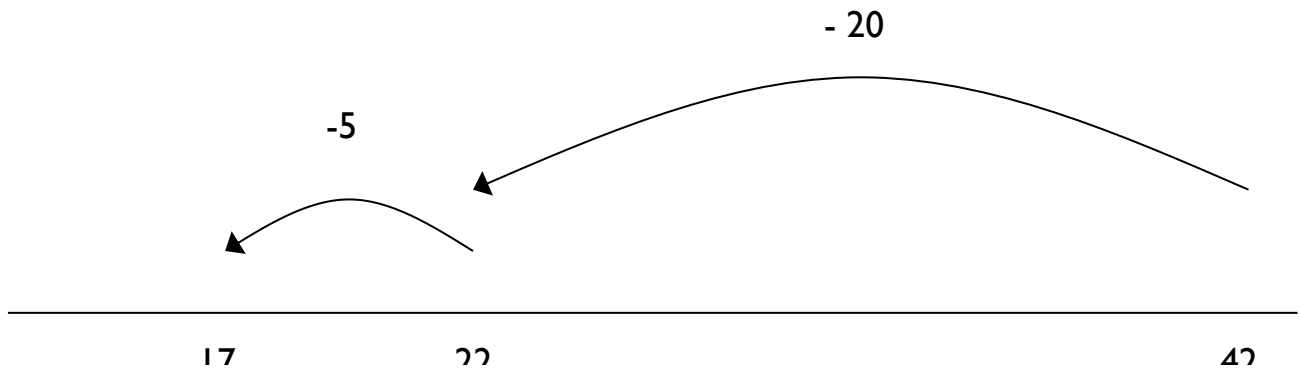

$42 - 25 = 17$ (shown using number sentences)

$$42 - 20 = 22$$

$$22 - 5 = 17$$

Reorder numbers in a calculation

In Y3, children need to build on their knowledge gained in Y2 and continue to reorder calculations to make them more efficient. (See Y2 for more information).

Examples of calculations:

$23 + 54$

$54 + 23$

$12 + 19 + 12$

$12 + 12 + 19$ (using knowledge of doubles)

$6 + 8 + 4$

$6 + 4 + 8$ (using knowledge of number bonds to 10)

$70 + 50 + 30$

$70 + 30 + 50$ (using knowledge of number bonds to 100)

Prerequisite skills:

- Understand the place value of numbers to identify which number is the greater
- Understand that reordering works for addition but not subtraction* (because children are not at the level when they are solving calculations such as $16 - 3 - 6$, when reordering would be appropriate).

Identify and use knowledge of number bonds within a calculation

Number bonds to 10 and 100 can be used to make calculations more efficient when combined with other strategies such as reordering and partitioning.

Examples of calculations:

$42 + 38$

$42 + 30 + 8$ (recognising that 2 and 8 is a number bond to 10, so the answer will be a multiple of 10)

$60 - 28$

$60 - 20 - 8$ (utilising knowledge that $10 - 8 = 2$, so $40 - 8 = 32$)

$120 - 50$

$120 - 20 - 30$ (utilising knowledge of number bonds to 100, leaving an answer of 70)

Prerequisite skills:

- Know, or quickly derive, number bonds to 10 and 100
- Identify number bonds within other numbers, e.g. identifying $7 + 3$ within the calculation $57 + 33$
- Identify that when adding two two-digit numbers, that $57 + 43 = 100$ but $57 + 53$ does not and why

Find differences by counting up through the next multiple of 10 or 100

In Y3, children need to build on their knowledge and understanding gained in Y2 to find larger differences that cross 10 and 100 boundaries. Some of these calculations are preparing children for time and money calculations throughout KS2.

Examples of calculations:

60 – 43	useful for time calculations, e.g. a journey time from 2:43 until 3:00
53 – 38	efficient because the numbers are close to each other
104 – 95	efficient because the numbers are close to each other
200 – 86	useful for money calculations, e.g. change from £2 when spending 86p

Prerequisite skills:

- Understand the place value of numbers to identify which number is the greater or lesser
- Establish whether numbers are close together or near to multiples of 10 or 100
- Place numbers appropriately on an unmarked numberline
- Count forwards and backwards in ones and tens

Children could use empty numberlines to record the calculation.

$$53 - 38 = 15$$

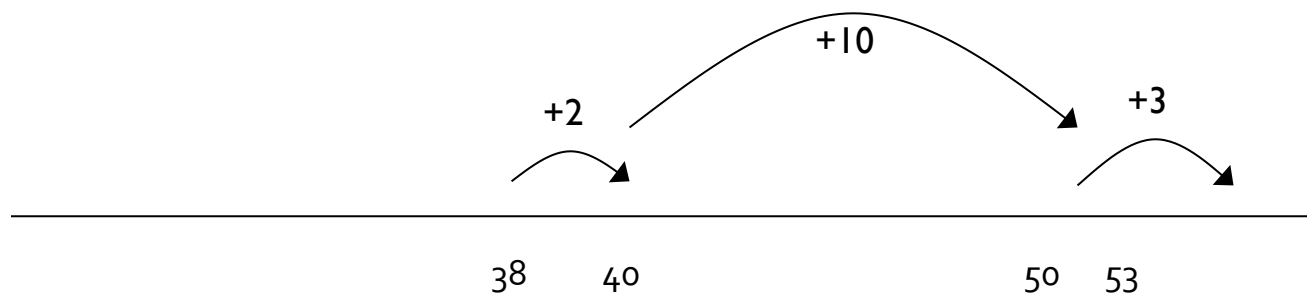

$$200 - 86 = 114$$

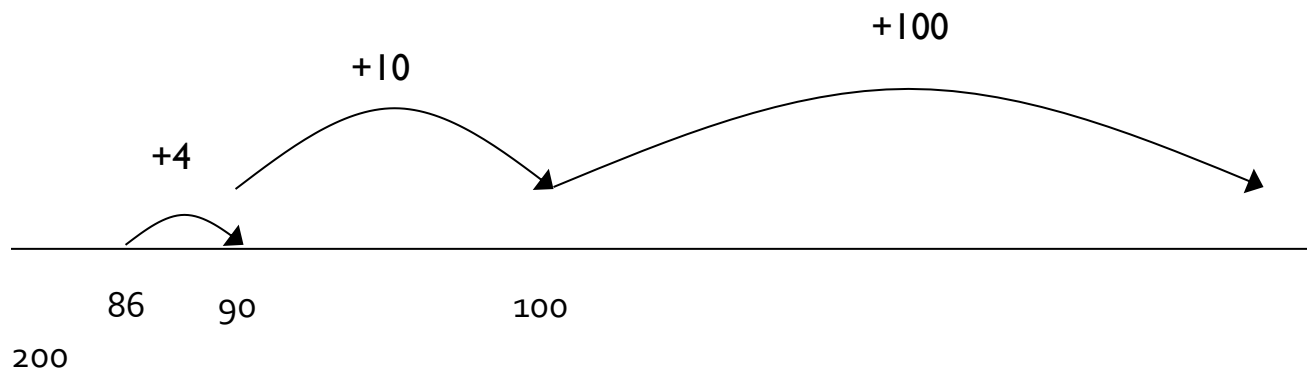

Bridge through 10 when adding or subtracting a single digit number (partitioning, e.g. $58 + 5 = 58 + 2 + 3$ or $76 - 8 = 76 - 6 - 2$)

In Y₃, children need to consolidate their knowledge and understanding gained in Y₂. (See Y₂ for more information).

Examples of calculations

$$35 + 7 \quad \text{as } 35 + 5 + 2$$

$$97 + 6 \quad \text{as } 97 + 3 + 3$$

$$178 + 5 \quad \text{as } 178 + 2 + 3$$

$$42 - 7 \quad \text{as } 42 - 2 - 5$$

$$204 - 6 \quad \text{as } 204 - 4 - 2$$

$$371 - 5 \quad \text{as } 371 - 1 - 4$$

Prerequisite skills:

- Partition numbers in different ways, e.g. 5 as 2 + 3 to enable $58 + 5$ as $58 + 2 + 3$
- Know, or quickly derive, number bonds to 10

Children could use empty numberlines to record the calculation.

$$198 + 6 = 204$$

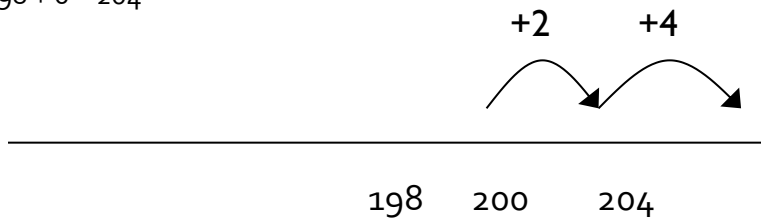

$$153 - 7 = 146$$

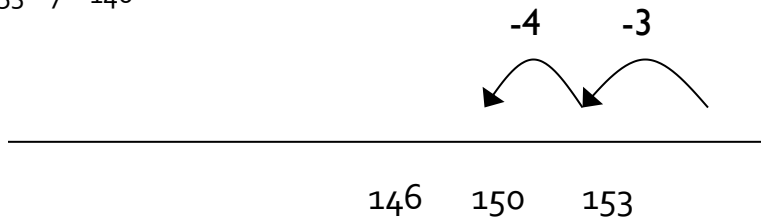

The bridging strategy can then be linked with the partitioning strategy for efficient addition and subtraction of two two-digit numbers.

Add or subtract 9, 19, 29 etc by rounding and compensating

In Y3, children need to build on their knowledge and understanding gained in Y2 (*See Y2 for more information*) to add and subtract one less than a multiple of 10 up to 89 to two and three-digit numbers.

Examples of calculations

$$34 + 29 \text{ as } 34 + 30 - 1$$

$$127 + 49 \quad \text{as } 127 + 50 - 1$$

$$96 - 39 \quad \text{as } 96 - 40 + 1$$

$$273 - 59 \text{ as } 273 - 60 + 1$$

Prerequisite skills:

- Identify the difference between the number being added and subtracted and the multiple of 10
- Understand that the adjustment needs to be the opposite of the operation carried out

$127 + 49 = 176$ (shown using a numberline)

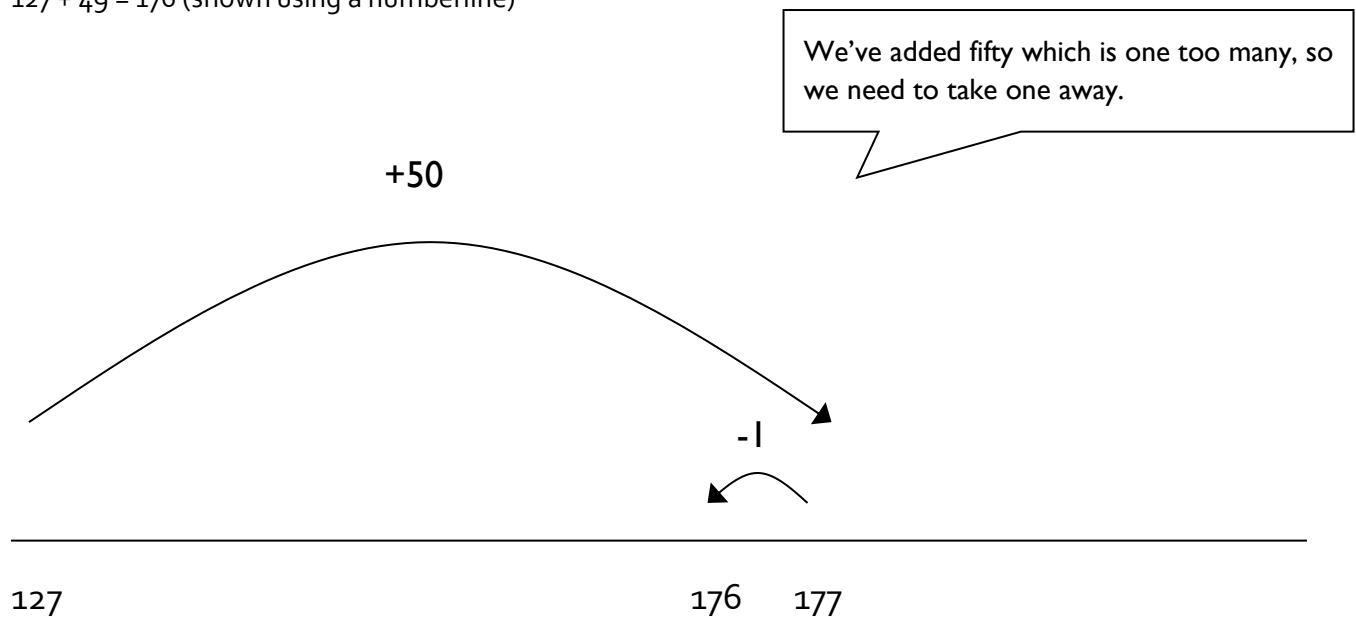

$127 + 49 = 176$ (shown using number sentences)

$$127 + 50 = 177$$

$$177 - 1 = 176$$

273 - 59 = 214 (shown using a numberline)

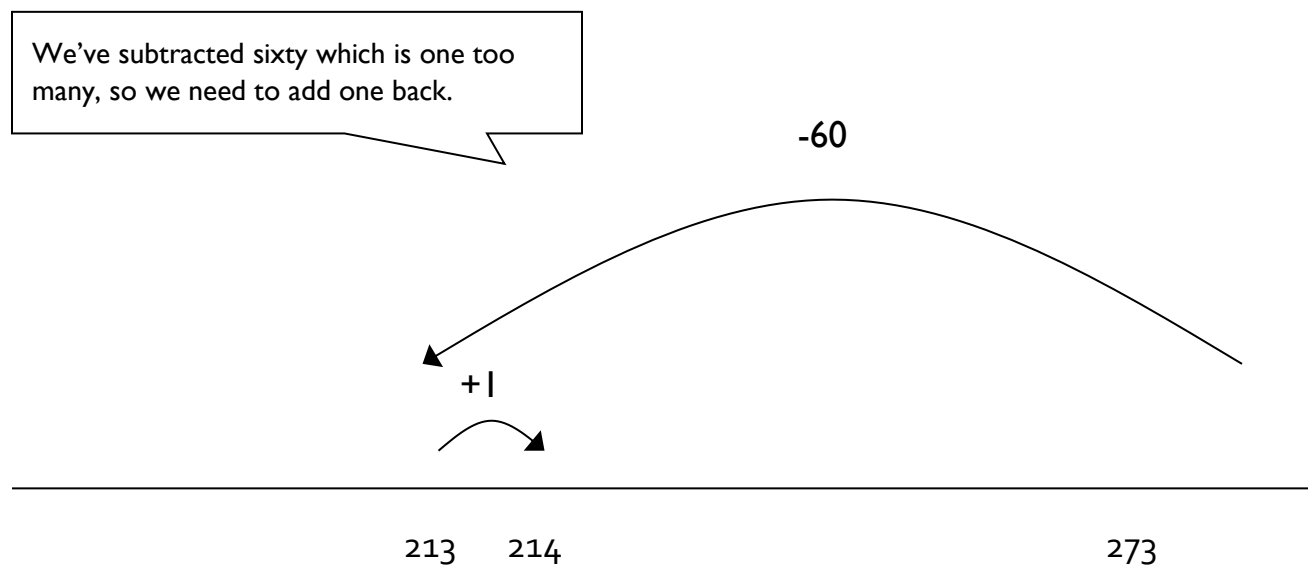

273 - 59 = 214 (shown using number sentences)

$$273 - 60 = 213$$

$$213 + 1 = 214$$

Y4

End of Year Objective:

Add and subtract numbers mentally, including: a three-digit number to or from a three-digit multiple of tens; two three-digit numbers (where there is no carrying or exchange involved)

Rapid Recall:

Children should be able to:

- recall and use addition and subtraction facts for 100
- recall and use addition and subtraction facts for multiples of 100 that total 1000
- derive and use addition and subtraction facts for 1 and 10 (with decimal numbers to one decimal place)

Mental Strategies

Partition and combine multiples of hundreds, tens and ones

Partitioning numbers is a core strategy for adding and subtracting pairs of numbers. Children can either partition both of the numbers in the calculation, or keep the first number the same and just partition the second. (*See Y2 and Y3 for more information*).

Examples of calculations:

$320+150$	320 add 100 and 50 = 320 add 100 add 50
$243+230$	243 add 200 and 30 = 243 add 200 add 30
$460-140$	460 take away 100 and 40 = 460 take away 100 take away 40
$562-320$	562 take away 300 and 20 = 562 take away 300 take away 20
$234+125$	234 add 100 and 20 and 5 = 234 add 100 add 20 add 5 (crossing no boundaries)
$765-241$	765 take away 200 and 40 and 1 = 765 take away 200 take away 40 take away 1 (crossing no boundaries)
$85+47$	85 add 40 and 7 = 84 add 40 add 7 (crossing hundreds and tens boundaries)
$122-35$	122 take away 30 and 5 = 122 take away 30 take away 5 (crossing hundreds and tens boundaries)

Prerequisite skills:

- Count forwards and backwards in ones, tens and hundreds from any one-, two- or three-digit number
- Understand place value and understand which digit changes if one, ten or hundred is added or subtracted
- Partition numbers into hundreds, tens and ones

$85 + 47 = 132$ (shown using a numberline)

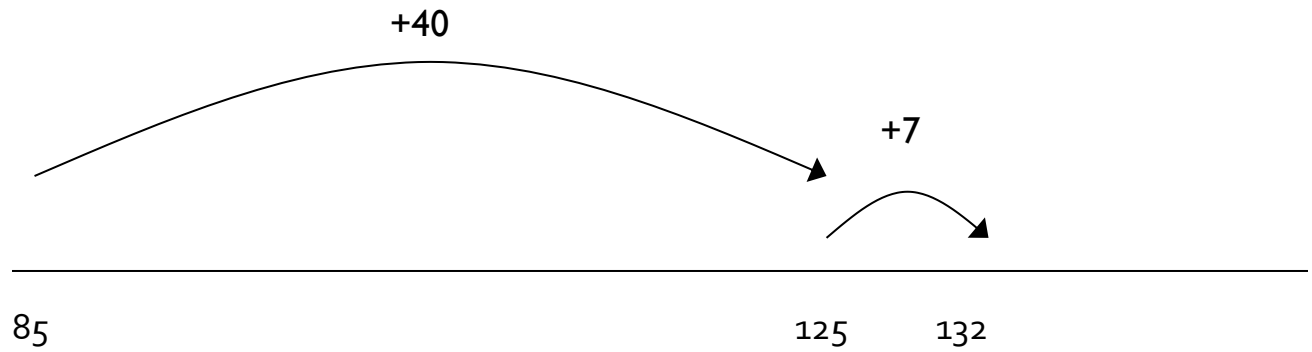

$85 + 47 = 132$

$85 + 40 = 125$

$125 + 7 = 132$

$122 - 35 = 87$ (shown using a numberline)

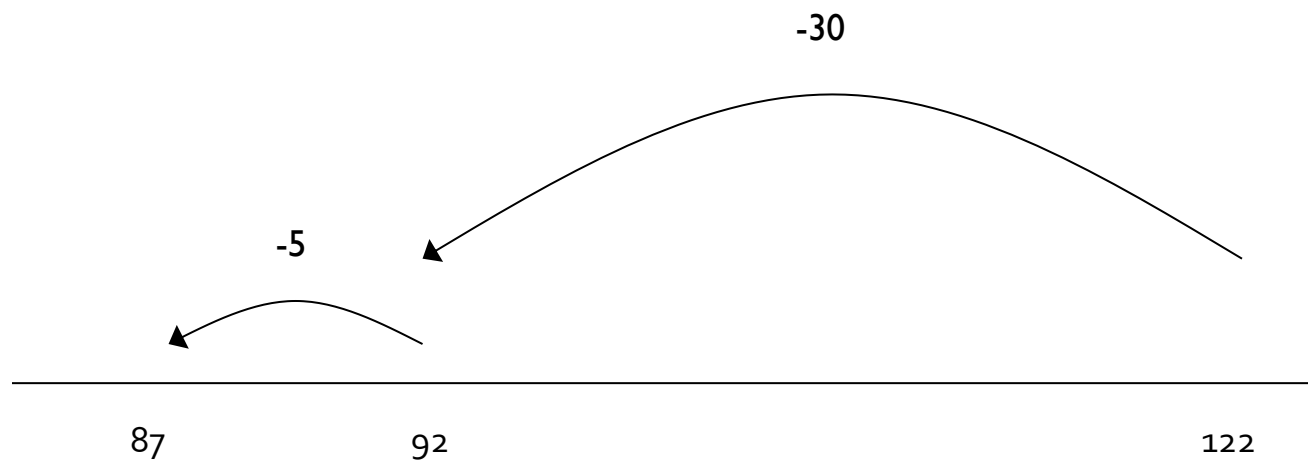

$122 - 35 = 87$ (shown using number sentences)

$$122 - 30 = 92$$

$$92 - 5 = 87$$

Reorder numbers in a calculation

In Y4, children need to build on their knowledge gained in Y3 and continue to reorder calculations to make them more efficient. They should now be solving calculations involving subtraction such as $16 - 3 - 6$, when reordering would be appropriate.

Examples of calculations:

$$7 + 12 + 3 + 5$$

$$7 + 3 + 12 + 5$$

$$18 + 6 - 8$$

$$18 - 8 + 6$$

$$27 + 75$$

$$75 + 27 \text{ (thinking of 27 as } 25 + 2)$$

Prerequisite skills:

- Understand the place value of numbers to identify which number is the greater
- Understand that reordering works for addition but not subtraction

Identify and use knowledge of number bonds within a calculation and identify related facts, e.g. $150 + 270$ from $15 + 27$

Children should use their knowledge of the number system to help them use related facts to calculate, e.g. 15 is ten times bigger than 150, 270 is ten times bigger than 27, so the answer to $150 + 270$ will be ten times bigger than $15 + 27$.

Examples of calculations:

$$120 + 80$$

using knowledge of $12 + 8 = 20$

$$250 + 130$$

using knowledge of $25 + 13 = 38$

$$200 - 70$$

using knowledge of $20 - 7 = 13$

$$460 - 150$$

using knowledge of $46 - 15 = 31$

Prerequisite skills:

- Know, or quickly derive, number bonds to 10, 100 or 1000
- Identify number bonds within other numbers, e.g. identifying 7 + 3 within the calculation 257 + 343
- Identify that when adding two two-digit numbers, that 57 + 43 = 100 but 57 + 53 does not and why

Find differences by counting up through the next multiple of 10 or 100

In Y₄, children need to build on their knowledge and understanding gained in Y₃ to find larger differences that cross 10 and 100 boundaries. When deciding whether to use a mental or a written method for a calculation, **children should be encouraged to select the method which is most efficient**. e.g. 203 – 96 =. It is more efficient to count up from 96 to 203 in three steps (+4, +100, +3) than to use the formal written method of:

$$\begin{array}{r} \overset{1}{2} \overset{9}{0} \overset{1}{3} \\ - \quad 96 \\ \hline \underline{107} \end{array}$$

which requires a lot of exchanging.

Examples of calculations:

$$80 - 43$$

$$92 - 35$$

$$203 - 96$$

$$504 - 180$$

Prerequisite skills:

- Understand the place value of numbers to identify which number is the greater or lesser
- Establish whether numbers are close together or near to multiples of 10 or 100

- Place numbers appropriately on an unmarked numberline
- Count forwards and backwards in ones and tens

Children could use empty numberlines to record the calculation.

$$92 - 35 = 57$$

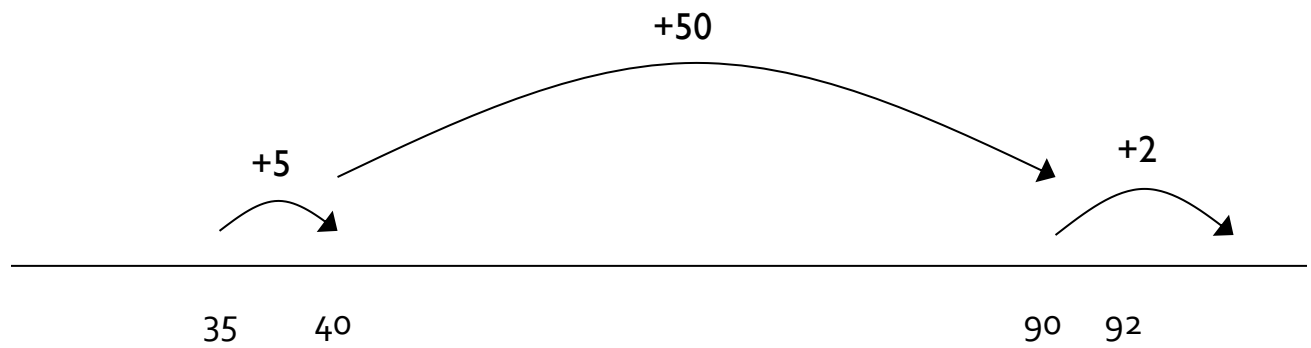

$$504 - 180 = 324$$

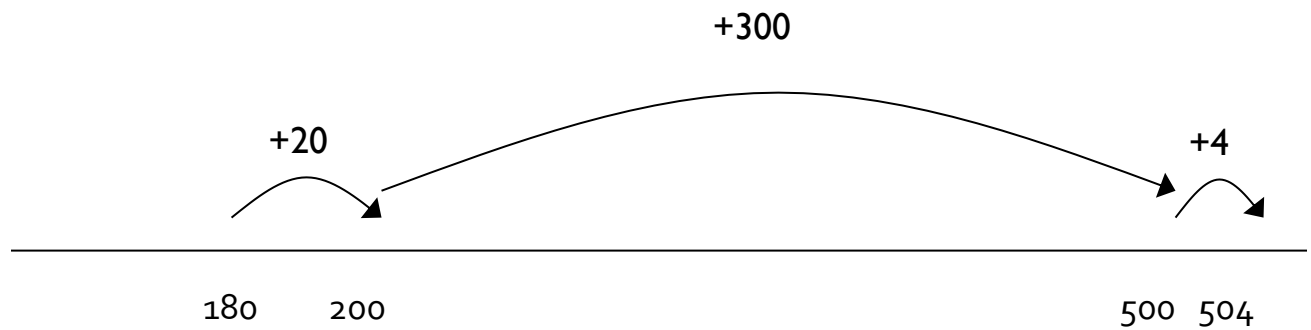

Bridge through 10 when adding or subtracting a single digit number (partitioning, e.g. $58 + 5 = 58 + 2 + 3$ or $76 - 8 = 76 - 6 - 2$)

In Y₄, children need to build on their knowledge and understanding gained in Y₃. (See Y₃ for more information).

Examples of calculations:

$$48 + 35 \text{ as } 48 + 2 + 33$$

$$97 + 64 \text{ as } 97 + 3 + 61$$

$$103 - 25 \quad \text{as } 103 - 3 - 22 \text{ (using number bonds to 100)}$$

$$230 - 72 \quad \text{as } 230 - 30 - 40 - 2$$

Prerequisite skills:

- Partition numbers in different ways, e.g. 5 as 2 + 3 to enable $58 + 5$ as $58 + 2 + 3$
- Know, or quickly derive, number bonds to 10

Children could use empty numberlines to record the calculation.

$$97 + 64 = 161$$

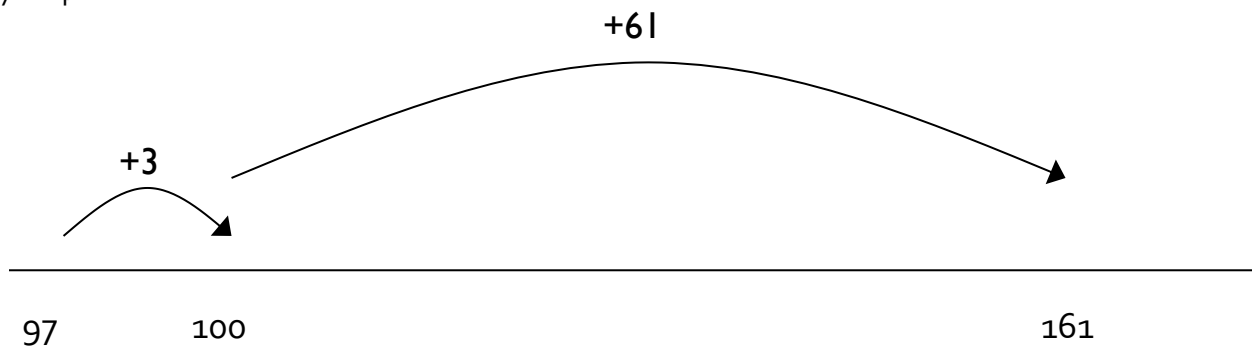

$$230 - 72 = 158$$

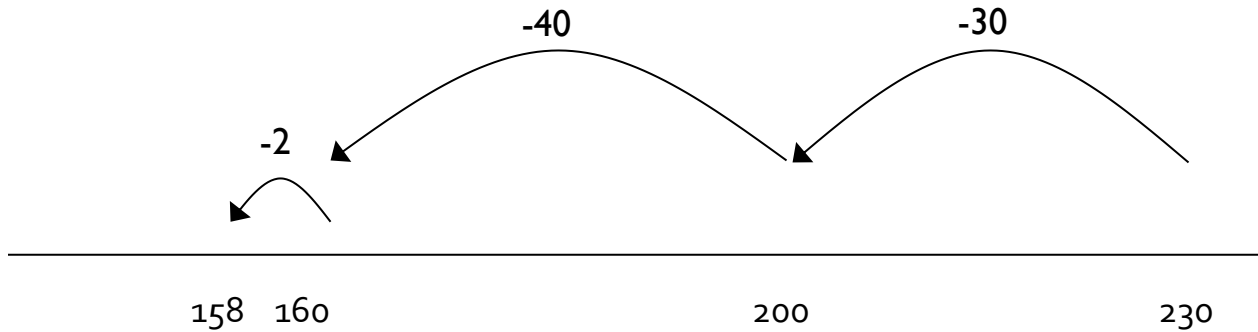

Add or subtract a multiple of 10 and adjust (for those numbers close to multiples of 10)

In Y₄, children need to build on their knowledge and understanding gained in Y₃ (*See Y₃ for more information*) to add and subtract numbers close to a multiple of 10 up to 89 to two and three-digit numbers.

Examples of calculations:

$$84 + 28 \text{ as } 84 + 30 - 2$$

$$167 + 48 \quad \text{as } 167 + 50 - 2$$

$$96 - 38 \quad \text{as } 96 - 40 + 2$$

$$213 - 58 \text{ as } 213 - 60 + 2$$

Prerequisite skills:

- Identify the difference between the number being added and subtracted and the multiple of 10
- Understand that the adjustment needs to be the opposite of the operation carried out

$167 + 48 = 215$ (shown using a numberline)

We've added fifty which is two too many, so we need to take two away.

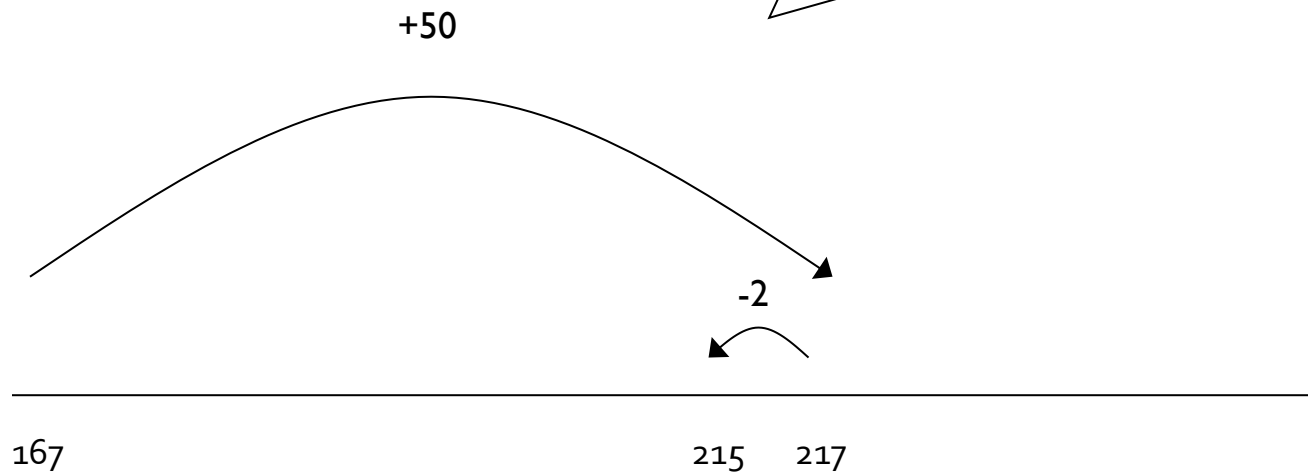

$167 + 48 = 215$ (shown using number sentences)

$$167 + 50 = 217$$

$$217 - 2 = 215$$

$213 - 58 = 155$ (shown using a numberline)

We've subtracted sixty which is two too many, so we need to add two back.

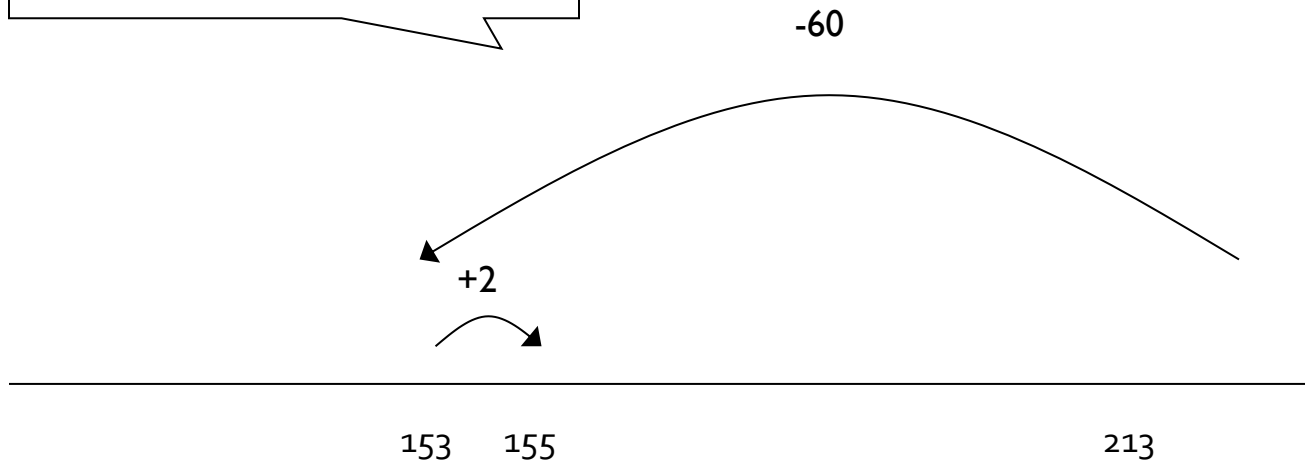

$213 - 58 = 155$ (shown using number sentences)

$213 - 60 = 153$

$153 + 2 = 155$

Y5

End of Year Objective:

Add and subtract numbers mentally, including: two three-digit numbers where one or both are multiples of 10 or 100; two or three-digit numbers to or from a four digit number; two four-digit numbers (where there is no carrying or exchange involved); pairs of decimals to one decimal place

Rapid Recall:

Children should be able to:

- Recall and use addition and subtraction facts for 1 and 10 (with decimal numbers to one decimal place)
- Derive and use addition and subtraction facts for 1 (with decimal numbers to two decimal places)

Mental Strategies

Partition and combine multiples of thousands hundreds, tens and ones

Partitioning numbers is a core strategy for adding and subtracting pairs of numbers. Children can either partition both of the numbers in the calculation, or keep the first number the same and just partition the second. (See Y2, Y3 and Y4 for more information).

Examples of calculations:

$4300 + 1400$	4300 add 1000 and 400 = 4300 add 1000 add 400
$364 + 250$	364 add 200 and 50 = 364 add 200 add 50
$3600 - 1200$	3600 take away 1000 and 200 = 3600 take away 1000 take away 200
$432 - 240$	432 take away 200 and 40 = 432 take away 200 take away 40
$5124 + 1352$	5124 add 1000 and 300 and 50 and 2 = 5124 add 1000 add 300 add 50 add 2 (crossing no boundaries)
$7584 - 2351$	7584 take away 2000 and 300 and 50 and 1 = 7584 take away 2000 take away 300 take away 50 take away 1 (crossing no boundaries)

Prerequisite skills:

- Count forwards and backwards in ones, tens, hundreds and thousands
- Understand place value and understand which digit changes if one, ten or hundred is added or subtracted
- Partition numbers into hundreds, tens and ones

$364 + 250 = 614$ (shown using a numberline)

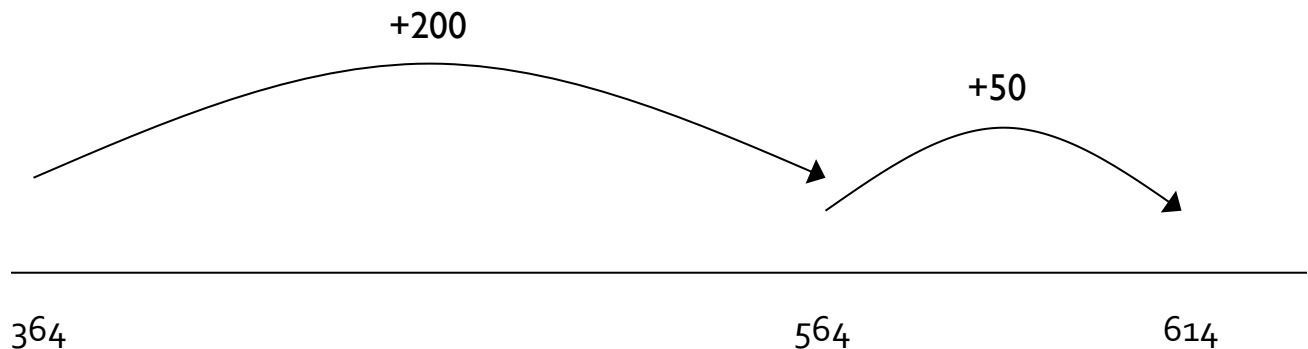

$364 + 250 = 614$ (shown using number sentences)

$$364 + 200 = 564$$

$$564 + 50 = 614$$

$432 - 240 = 192$ (shown using a numberline)

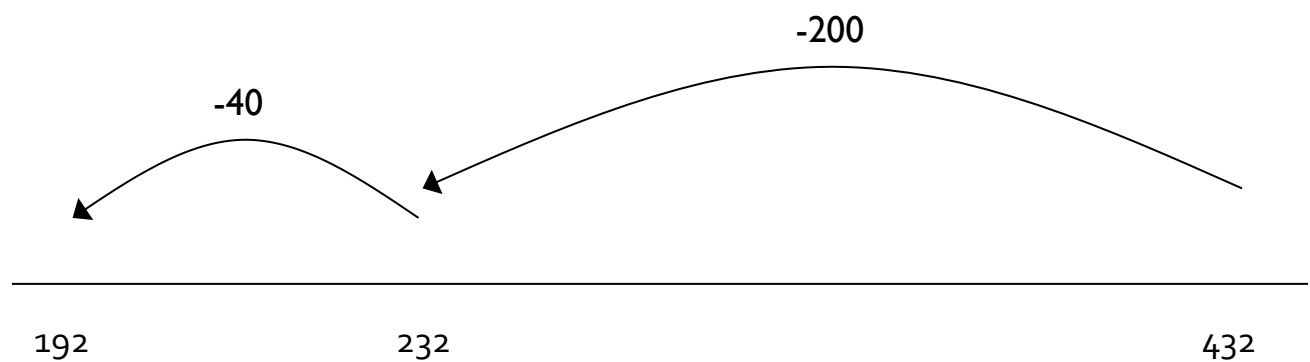

$432 - 240 = 192$ (shown using number sentences)

$$432 - 200 = 232$$

$$232 - 40 = 192$$

Partition and combine multiples of ones and tenths

Partitioning numbers is a core strategy for adding and subtracting pairs of numbers. Children can either partition both of the numbers in the calculation, or keep the first number the same and just partition the second. The calculations do not cross ones boundaries.

Examples of calculations:

$$5.4 + 3.2$$

$$5.4 \text{ add } 3 \text{ and } 0.2 = 5.4 \text{ add } 3 \text{ add } 0.2$$

$4.7 - 2.5$

4.7 take away 2 and 0.5 = 4.7 take away 2 take away 0.5

Prerequisite skills:

- Count forwards and backwards in tenths and ones
- Understand place value of decimal numbers

$5.4 + 3.2 = 8.6$ (shown using a numberline)

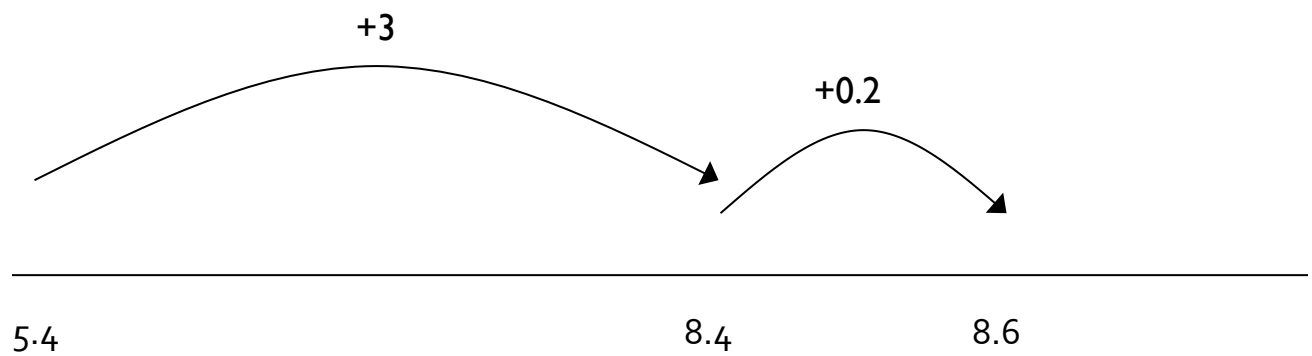

$5.4 + 3.2 = 8.6$ (shown using number sentences)

$5.4 + 3 = 8.4$

$8.4 + 0.2 = 8.6$

$4.7 - 2.5 = 2.2$ (shown using a numberline)

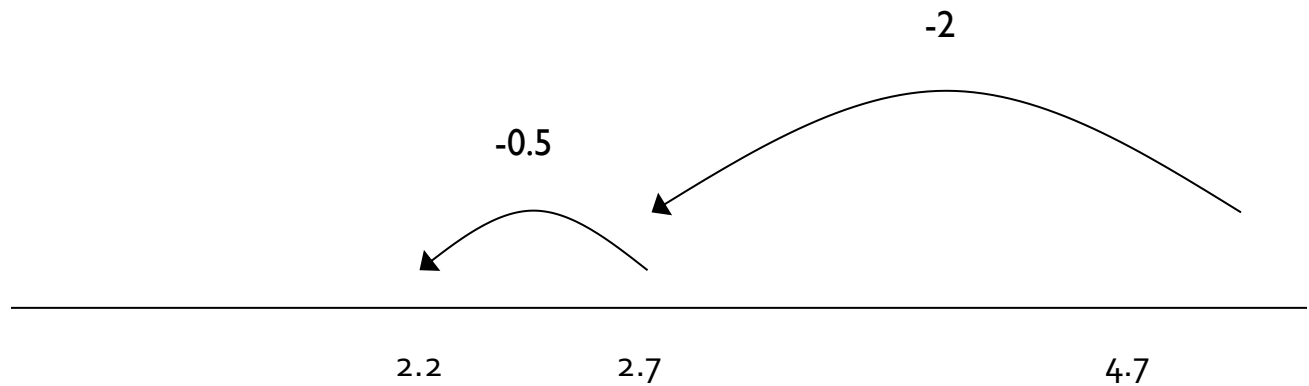

$4.7 - 2.5 = 2.2$ (shown using number sentences)

$$4.7 - 2 = 2.7$$

$$2.7 - 0.5 = 2.2$$

Identify and use knowledge of number bonds within a calculation and identify related facts, e.g. $1.5 + 2.7$ from $15 + 27$

Children should use their knowledge of the number system to help them use related facts to calculate, e.g. 1.5 is ten times smaller than 15, 2.7 is ten times smaller than 27, so the answer to $1.5 + 2.7$ will be ten times smaller than $15 + 27$.

Examples of calculations:

$1.2 + 0.8$ using knowledge of $12 + 8 = 20$

$2.5 + 1.3$ using knowledge of $25 + 13 = 38$

$3.8 + 4.5$ using knowledge of $38 + 45 = 83$

$2 - 0.7$ using knowledge of $20 - 7 = 13$

$4.6 - 1.5$ using knowledge of $46 - 15 = 31$

$8.3 - 5.4$ using knowledge of $83 - 54 = 29$

Prerequisite skills:

- Know, or quickly derive, number bonds to 1, 10, 100 1000
- Identify number bonds within other numbers, e.g. identifying
- 7 + 3 within the calculations 257 + 343 or 1.7 + 2.3

Find differences by counting up through the next multiple of 1, 10, 100 or 1000

In Y5, children need to build on their knowledge and understanding gained in Y4 to find differences that cross 1, 10, 100 and 1000 boundaries. When deciding whether to use a mental or a written method for a calculation, **children should be encouraged to select the method which is most efficient.**

e.g. $5003 - 1960 =$. It is more efficient to count up from 1960 to 5003 in three steps (+40, +3000, +3) than to use the formal written method of:

$$\begin{array}{r} \overset{4}{5} \overset{9}{0} \overset{1}{0} 3 \\ - 1960 \\ \hline \underline{3043} \end{array}$$

which requires a lot of exchanging.

Examples of calculations:

$$604 - 289$$

$$523 - 160$$

$$1200 - 785$$

$$5003 - 1960$$

$$7.3 - 2.8$$

$$20.1 - 6.7$$

Prerequisite skills:

- Understand the place value of numbers to identify which number is the greater or lesser
- Establish whether numbers are close together or near to multiples of 10 or 100
- Place numbers appropriately on an unmarked numberline
- Count forwards and backwards in ones and tens

Children could use empty numberlines to record the calculation.

$$5003 - 1960 = 3043$$

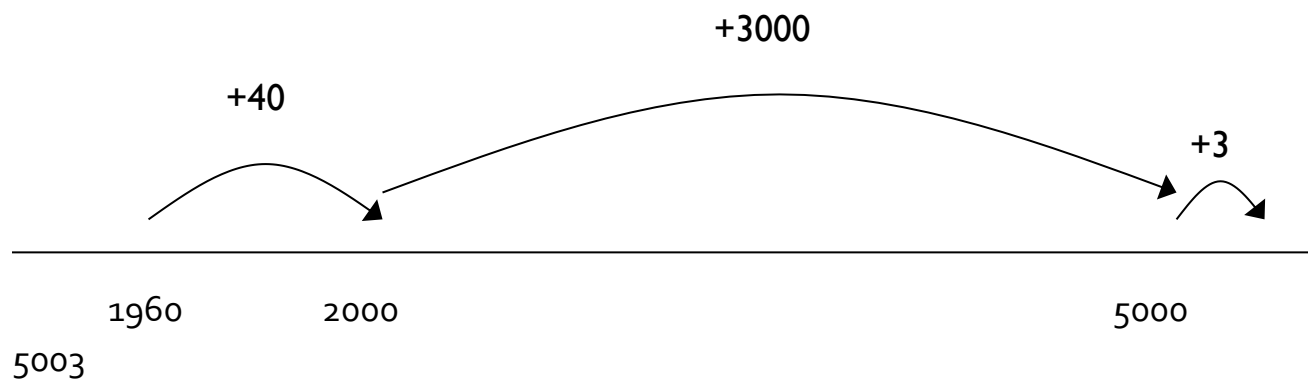

$$7.3 - 2.8 = 4.5$$

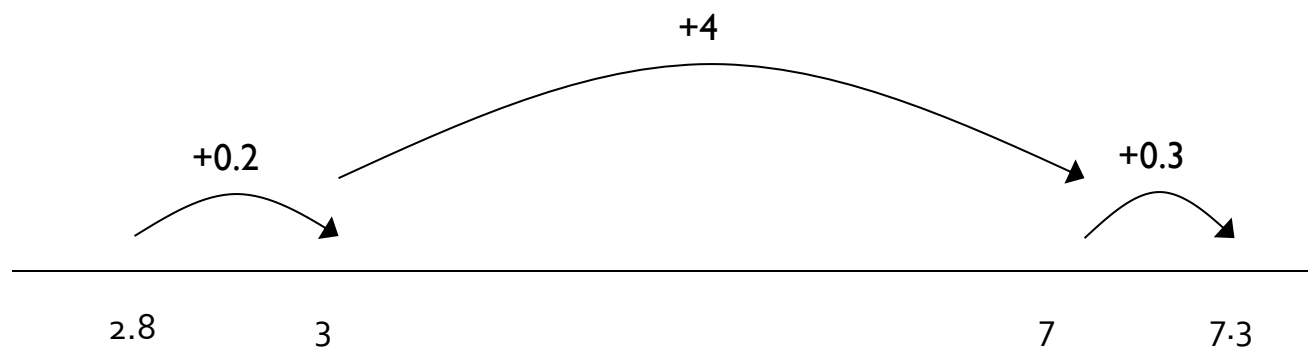

$$20.1 - 6.7 = 13.4$$

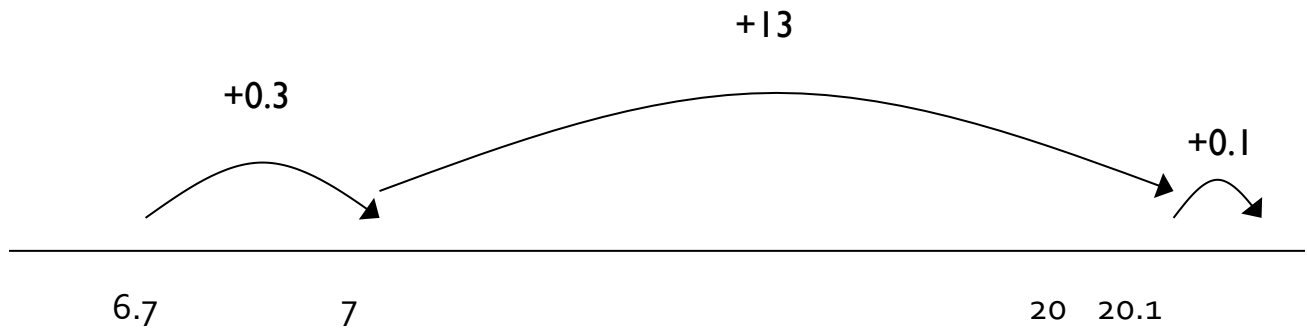

Bridge through 10 when adding or subtracting a single digit number (partitioning, e.g. $58 + 5 = 58 + 2 + 3$ or $76 - 8 = 76 - 6 - 2$)

In Y5, children need to build on their knowledge and understanding gained in Y4. (See Y4 for more information).

Examples of calculations:

$$594 + 170 \quad \text{as } 594 + 6 + 164$$

$$1995 + 278 \quad \text{as } 1995 + 5 + 273$$

$$703 - 128 \quad \text{as } 703 - 3 - 125$$

$$3002 - 87 \quad \text{as } 3002 - 2 - 85$$

Prerequisite skills:

- Partition numbers in different ways, e.g. 5 as 2 + 3 to enable $58 + 5$ as $58 + 2 + 3$
- Know, or quickly derive, number bonds to 10

Children could use empty numberlines to record the calculation.

$$1995 + 278 = 2273$$

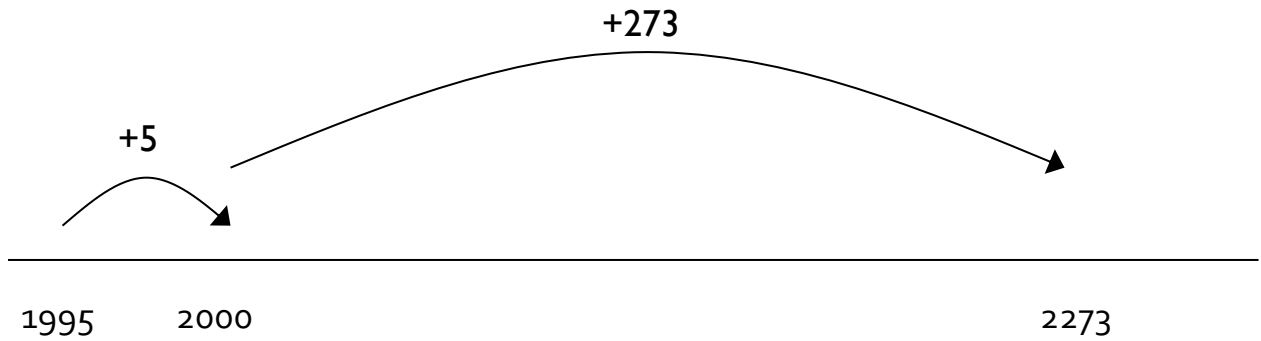

$$3002 - 87 = 2915$$

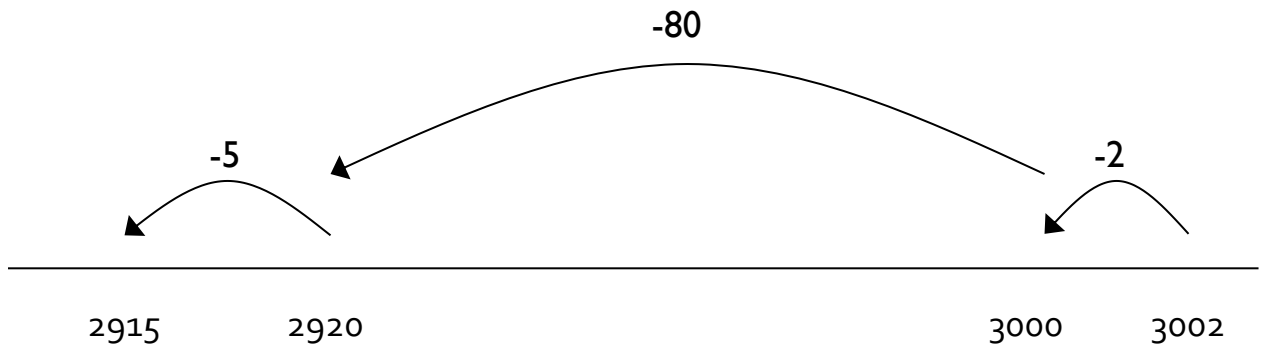

Add or subtract a multiple of 10 and adjust (for those numbers close to multiples of 10)

In Y5, children need to build on their knowledge and understanding gained in Y4 (See Y4 for more information) to add and subtract numbers close to a multiple of 10.

Examples of calculations:

$$\begin{array}{ll} 257 + 68 & \text{as } 257 + 70 - 2 \\ 325 + 298 & \text{as } 325 + 300 - 2 \end{array}$$

$$764 - 88 \text{ as } 764 - 90 + 2$$

$$876 - 397 \text{ as } 876 - 400 + 3$$

Prerequisite skills:

- Identify the difference between the number being added and subtracted and the multiple of 10
- Understand that the adjustment needs to be the opposite of the operation carried out

We've added three hundred which is two too many, so we need to take two away.

$325 + 298 = 623$ (shown using a numberline)

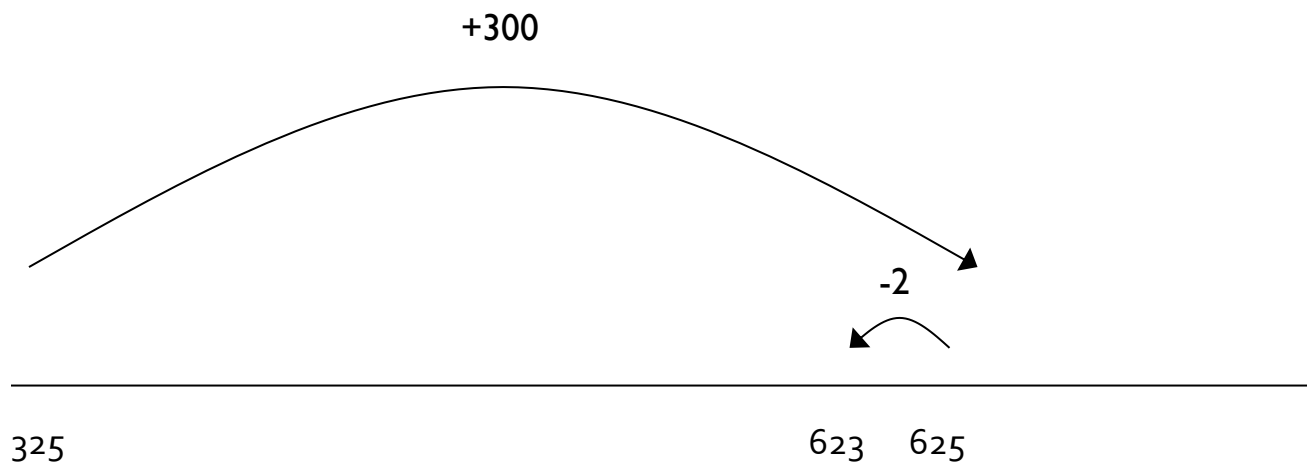

$325 + 298 = 623$ (shown using number sentences)

$$325 + 300 = 625$$

$$625 - 2 = 623$$

$876 - 397 = 479$ (shown using a numberline)

We've subtracted four hundred which is three too many, so we need to add three

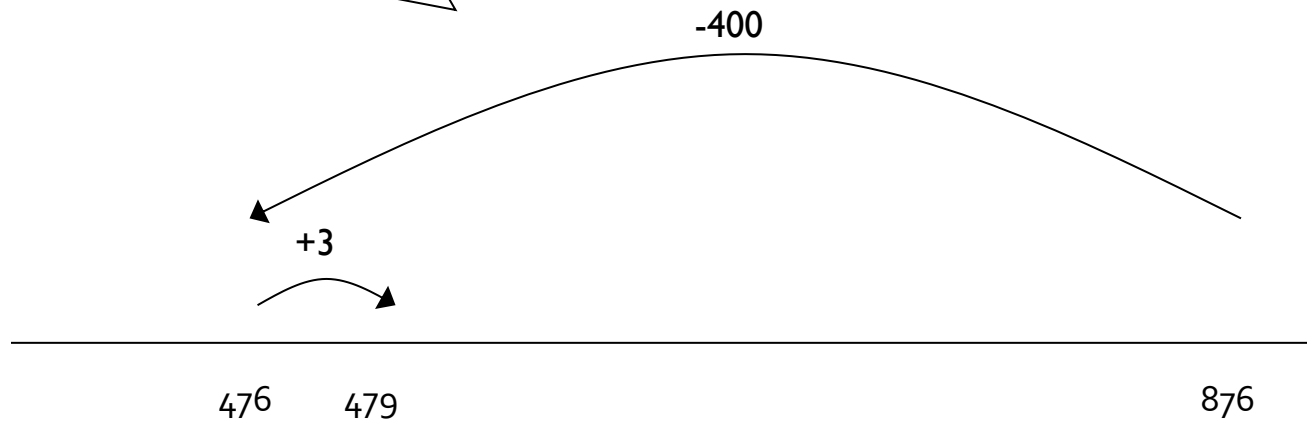

$876 - 397 = 479$ (shown using number sentences)

$$876 - 400 = 476$$

$$476 + 3 = 479$$

Y6

End of Year Objective:

Add and subtract numbers mentally, including: two three-digit numbers where one or both are multiples of 10 or 100; two or three-digit numbers to or from a four digit number; two four-digit numbers (where there is no carrying or exchange involved); pairs of decimals to one decimal place

Rapid Recall:

Children should be able to:

- Recall and use addition and subtraction facts for 1 (with decimal numbers to two decimal places)

Mental Strategies

Partition and combine multiples of thousands hundreds, tens and ones

Partitioning numbers is a core strategy for adding and subtracting pairs of numbers. Children can either partition both of the numbers in the calculation, or keep the first number the same and just partition the second. (See Y2, Y3, Y4 and Y5 for more information).

Examples of calculations:

$$5800 + 2400 \qquad 5800 \text{ add } 2000 \text{ and } 400 = 5800 \text{ add } 2000 \text{ add } 400$$

$$873 + 350 \qquad 873 \text{ add } 300 \text{ and } 50 = 873 \text{ add } 300 \text{ add } 50$$

$$4100 - 1600 \qquad 4100 \text{ take away } 1000 \text{ and } 600 = 4100 \text{ take away } 1000 \text{ take away } 600$$

$$2132 - 440 \qquad 2132 \text{ take away } 400 \text{ and } 40 = 2132 \text{ take away } 400 \text{ take away } 40$$

$$5124 + 1352 \qquad 5124 \text{ add } 1000 \text{ and } 300 \text{ and } 50 \text{ and } 2 = 5124 \text{ add } 1000 \text{ add } 300 \text{ add } 50 \text{ add } 2$$

(crossing no boundaries)

$$7584 - 2351 \qquad 7584 \text{ take away } 2000 \text{ and } 300 \text{ and } 50 \text{ and } 1 = 7584 \text{ take away } 2000 \text{ take away } 300 \text{ take away } 50 \text{ take away } 1$$

(crossing no boundaries)

Prerequisite skills:

- Count forwards and backwards in ones, tens, hundreds and thousands
- Understand place value and understand which digit changes if one, ten or hundred is added or subtracted
- Partition numbers into hundreds, tens and ones

$873 + 350 = 1223$ (shown using a numberline)

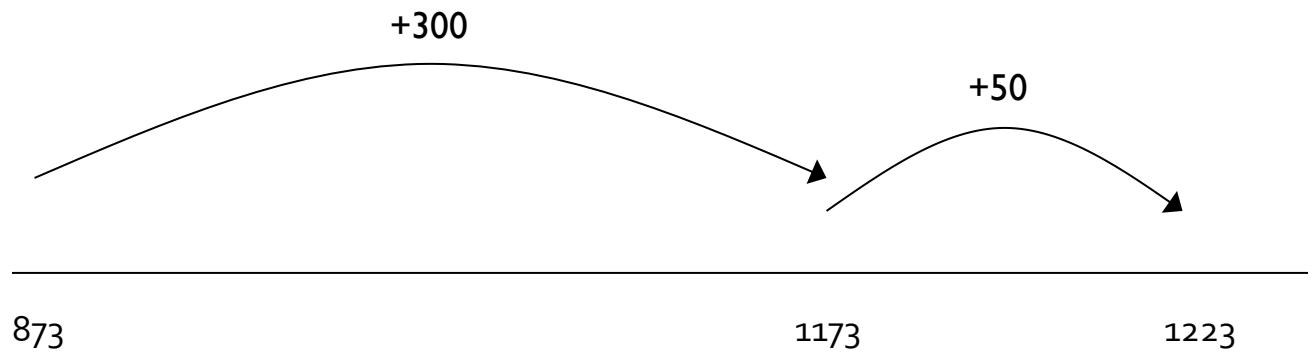

$873 + 350 = 1223$ (shown using number sentences)

$$873 + 300 = 1173$$

$$1173 + 50 = 1223$$

$2132 - 440 = 1692$ (shown using a numberline)

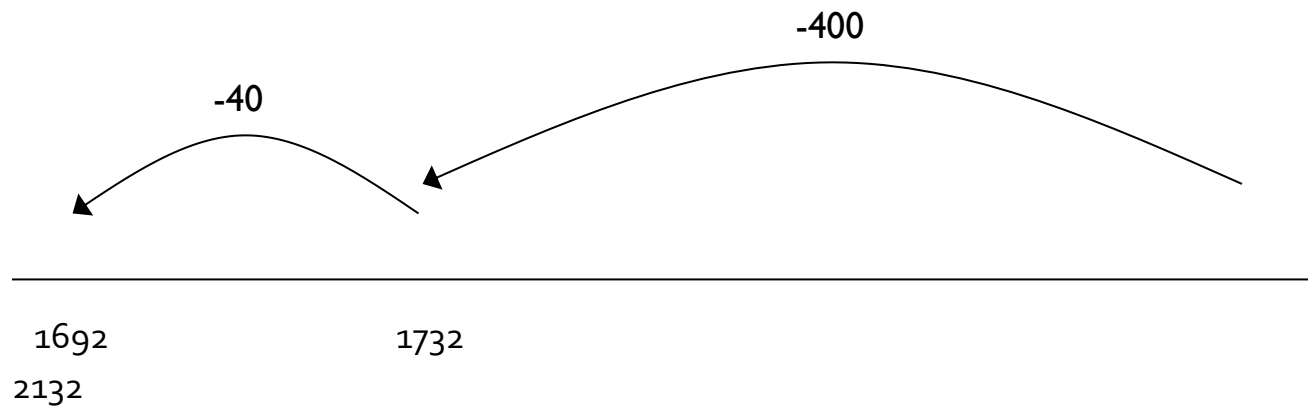

$2132 - 440 = 1692$ (shown using number sentences)

$$2132 - 400 = 1732$$

$$1732 - 40 = 1692$$

Partition and combine multiples of ones and tenths

Partitioning numbers is a core strategy for adding and subtracting pairs of numbers. Children can either partition both of the numbers in the calculation, or keep the first number the same and just partition the second. The calculations include crossing ones boundaries. *(See Year 5 for more information)*

Examples of calculations:

$$8.4 + 3.8 \qquad 8.4 \text{ add } 3 \text{ and } 0.8 = 8.4 \text{ add } 3 \text{ add } 0.8$$

$$13.2 - 4.5 \qquad 13.2 \text{ take away } 4 \text{ and } 0.5 = 13.2 \text{ take away } 4 \text{ take away } 0.5$$

Prerequisite skills:

- Count forwards and backwards in tenths and ones
- Understand place value of decimal numbers

$8.4 + 3.8 = 12.2$ (shown using a numberline)

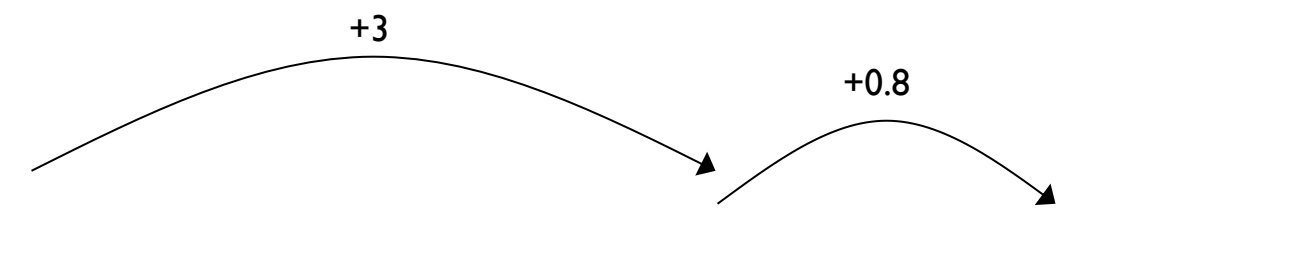

8.4

11.4

12.2

$8.4 + 3.8 = 12.2$ (shown using number sentences)

$$8.4 + 3 = 11.4$$

$$11.4 + 0.8 = 12.2$$

$13.2 - 4.5 = 8.7$ (shown using a numberline)

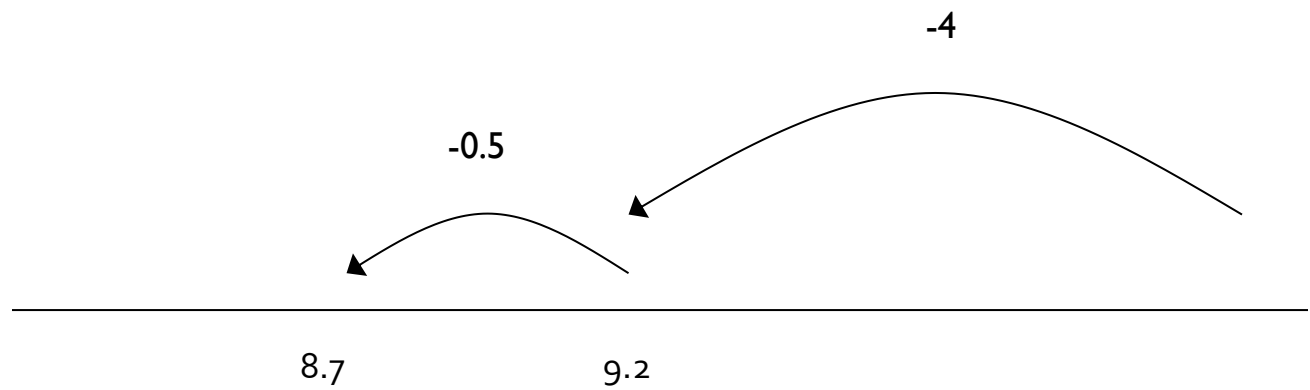

13.2

$13.2 - 4.5 = 8.7$ (shown using number sentences)

$$13.2 - 4 = 9.2$$

$$9.2 - 0.5 = 8.7$$

Identify and use knowledge of number bonds within a calculation and identify related facts, e.g. $680 + 430$, $6.8 + 4.3$, $0.68 + 0.43$ can all be worked out using the related calculation $68 + 43$

In Y6, children need to build on their knowledge and understanding gained in Y5 (See Y5 for more information) Children should use their knowledge of the number system to help them use related facts

to calculate, e.g. 0.68 is one hundred times smaller than 68, 0.43 is a hundred times smaller than 43, so the answer to $0.68 + 0.43$ will be a hundred times smaller than $68 + 43$.

Examples of calculations:

$0.62 + 0.38$	using knowledge of $62 + 38 = 100$
$0.75 + 0.56$	using knowledge of $75 + 56 = 131$
$2.8 + 0.43$	using knowledge of $280 + 43 = 323$
$1 - 0.41$	using knowledge of $100 - 41 = 59$
$0.92 - 0.35$	using knowledge of $92 - 35 = 57$
$8.3 - 0.52$	using knowledge of $830 - 52 = 778$

Prerequisite skills:

- Know, or quickly derive, number bonds to 1, 10, 100 1000
- Identify number bonds within other numbers, e.g. identifying
- 7 + 3 within the calculations $257 + 343$ or $1.7 + 2.3$

Find differences by counting up through the next multiple of 0.1, 1, 10, 100 or 1000

In Y6, children need to build on their knowledge and understanding gained in Y5 to find differences that cross 0.1, 10, 100 and 1000 boundaries. When deciding whether to use a mental or a written method for a calculation, children should be encouraged to select the method which is most efficient.

Examples of calculations:

$$8.2 - 3.46$$

$$14.23 - 7.58$$

Prerequisite skills:

- Understand the place value of numbers to identify which number is the greater or lesser
- Establish whether numbers are close together or near to multiples of 10 or 100
- Place numbers appropriately on an unmarked numberline
- Count forwards and backwards in ones and tens

Children could use empty numberlines to record the calculation.

$$8.2 - 3.46 = 4.74$$

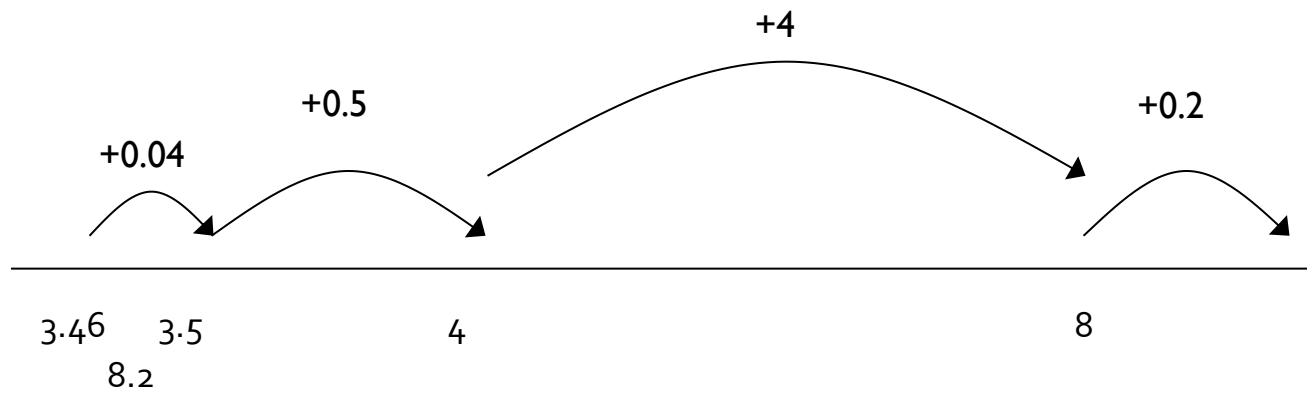

$$14.23 - 7.58 = 6.65$$

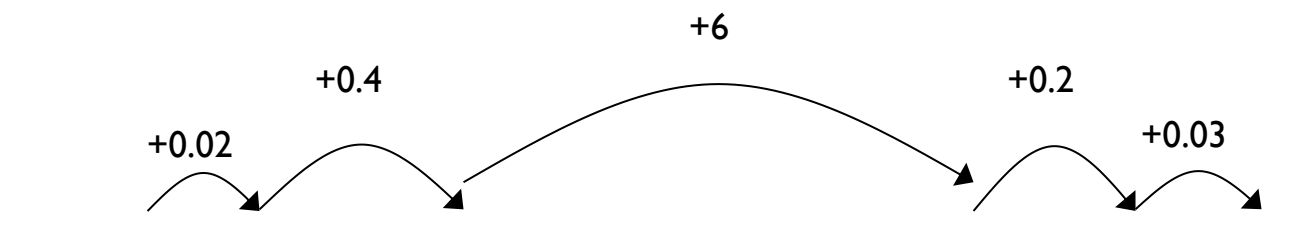

7.58 7.6 8

14 14.2 14.23

Bridge through 10 when adding or subtracting a single digit number (partitioning, e.g. $58 + 5 = 58 + 2 + 3$ or $76 - 8 = 76 - 6 - 2$)

In Y6, children bridge using decimals to one place. To do this, it is essential that children can partition decimal numbers in different ways, e.g. 2.5 into 2 and 0.5, 2.5 into 1 and 1.5, 2.5 into 2.1 and 0.4, etc.

Examples of calculations:

$$1.5 + 1.7 \text{ as } 1.5 + 0.5 + 1.2$$

$$0.7 + 0.56 \quad \text{as } 0.7 + 0.3 + 0.26$$

$$8.3 - 2.7 \quad \text{as } 8.3 - 2.3 - 0.4$$

Prerequisite skills:

- Partition numbers in different ways, e.g. 5 as 2 + 3 to enable $58 + 5$ as $58 + 2 + 3$
- Know, or quickly derive, number bonds to 10

Children could use empty numberlines to record the calculation.

$$1.5 + 1.7 = 3.2$$

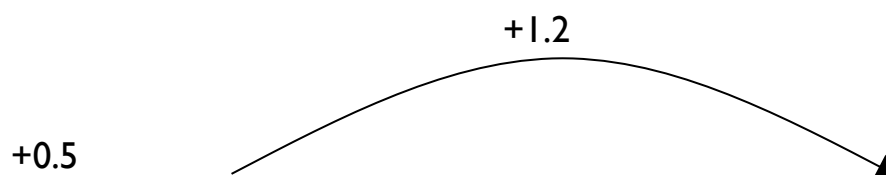

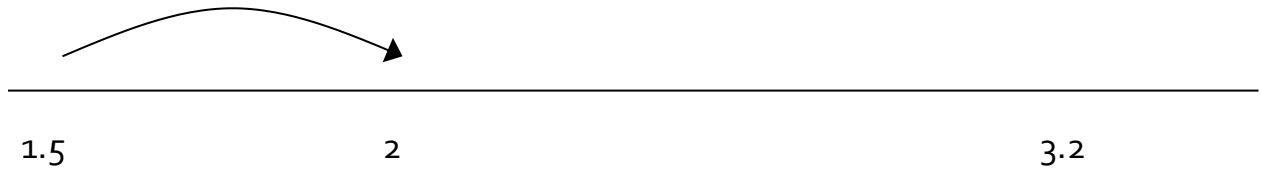

$$8.3 - 2.7 = 5.6$$

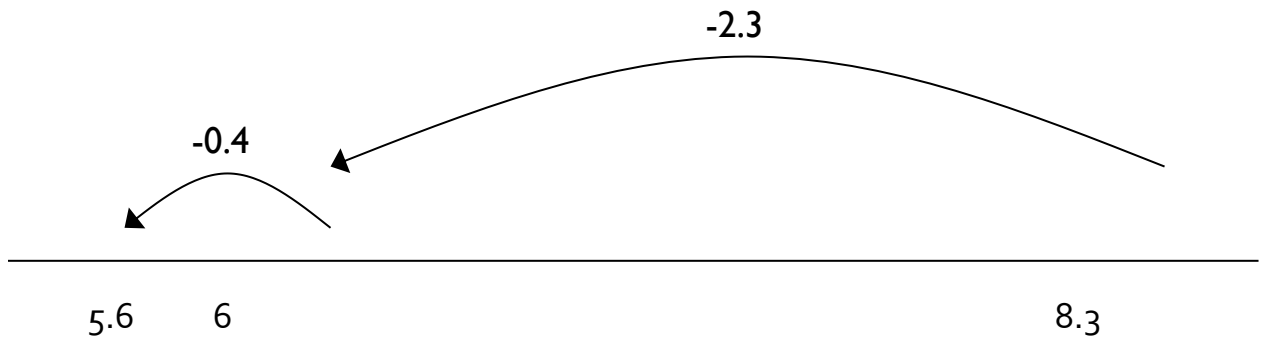

Add or subtract a multiple of 10 and adjust (for those numbers close to multiples of 10)

In Y6, children adjust calculations using decimals to one place.

Examples of calculations:

$$5.6 + 3.9 \quad - \text{ as } 5.6 + 4 - 0.1$$

$$7.5 - 4.8 \quad - \text{ as } 7.5 - 5 + 0.2$$

Prerequisite skills:

- Identify the difference between the number being added and subtracted and the multiple of 10
- Understand that the adjustment needs to be the opposite of the operation carried out

$5.6 + 3.9 = 9.5$ (shown using a numberline)

We've added four which is nought point one too many, so we need to take nought point one away.

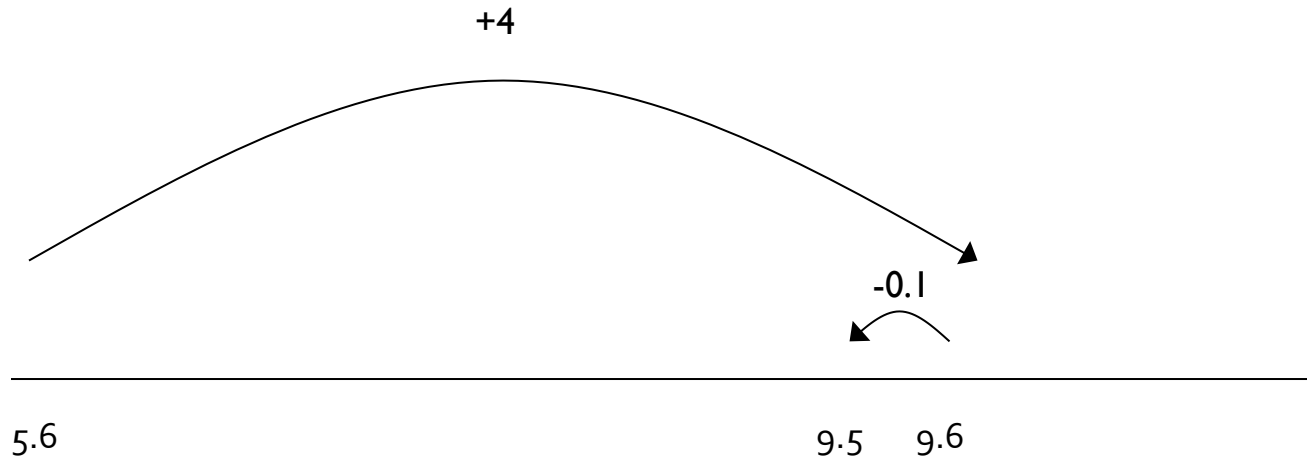

$5.6 + 3.9 = 9.5$ (shown using number sentences)

$$5.6 + 4 = 9.6$$

$$9.6 - 0.1 = 9.5$$

$7.5 - 4.8 = 2.7$ (shown using a numberline)

We've subtracted five which is nought point two too many, so we need to add nought point two back.

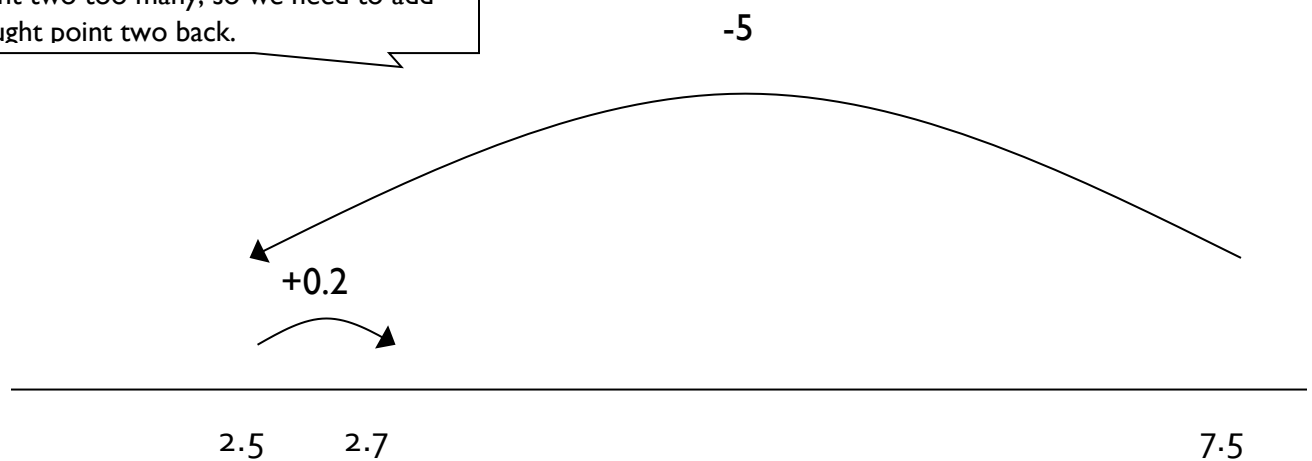

$7.5 - 4.8 = 2.7$ (shown using number sentences)

$$7.5 - 5 = 2.5$$

$$2.5 + 0.2 = 2.7$$