



William Perkin  
C of E  
High School



# Careers, Information, Advice and Guidance Bulletin

Autumn Term – 2025



# CONTENTS & INDEX

KS3 OPPORTUNITIES



APPRENTICESHIPS



CONTENTS / INDEX  
(THIS SLIDE)



SCIENCE, TECHNOLOGY,  
ENGINEERING, MATHS,  
MEDICINE



INFO, RESOURCES &  
OPEN DAYS



SOCIAL SCIENCES  
(HUMANITIES, FINANCE  
& LANGUAGES)



CIAG TEAM



CREATIVE ARTS  
(FASHION, MEDIA &  
PRODUCTIONS)



UPCOMING DEADLINE



PUBLIC SERVICE &  
VOLUNTEERING



LINK TO APPLY/ MORE  
INFO



This document contains **embedded links** for ease of viewing and accessing different sections.

It also contains **direct links** for school items, as well as items relating to the CIAG opportunities.

**All logos contain links** to either the company's home page or for more details about the CIAG opportunity, where available.

All links have been checked and verified, however as always, please take care when using links to external pages.

If there are any incorrect or broken links, please [email us](#).



# KS3 Opportunities



*'I have come that you should have life and life in all its fullness'*



# NHS

FOR YEARS:

KS3

The Step into the NHS competition introduces students to the more than 350 NHS careers so they are inspired and motivated to fulfil their potential, no matter their interests and skills.

We're challenging KS3 pupils to create a job advertisement showcasing one NHS role of their choice. The advert should include the key responsibilities of their chosen role, along with any qualifications, skills and experience.



# ARMED FORCES

FOR YEARS:

ALL

## British Armed Forces

Join us for an informative session designed to give you clarity and confidence about the opportunities the British Army offers young people. Whether your child is exploring options after school or college, or considering a meaningful career, this session will help you understand what's possible.

You'll discover what life in today's Army really looks like — from the variety of roles and world-class training to the qualifications and personal development available.

If you're curious about the Army, or you simply want to be informed, this session is here to support you every step of the way.



# ARMY



# CODE AVENGERS

FOR YEARS:  
7-8

Year 7 and 8 students are strongly encouraged to complete units on Code Avengers at home to improve their digital literacy and prepare for a digital future.

Studies show a significant difference in different sectors for employees with more advanced digital skills (specifically experience with artificial intelligence).

Units students should be completing at home:



## CODE AVENGERS

Salary Premia by Occupation Group, 2021

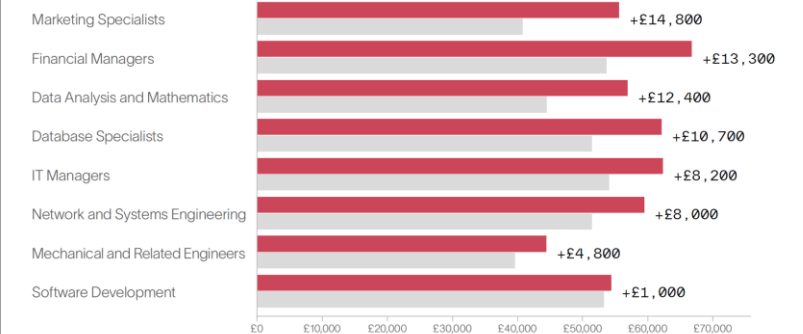

	Learning Content	Award
<b>Year 7</b> All students	<ul style="list-style-type: none"> <li>Autumn 1: Programming 3 (4 hours)</li> <li>Autumn 2: Computational Thinking 3 (4 hours)</li> <li>Spring 1: Programming 4 (3 hours)</li> <li>Spring 2: Data Representation 3 (2 hours)</li> <li>Summer 1: Data Representation 4 (3 hours)</li> </ul>	<ul style="list-style-type: none"> <li>CA Badge</li> <li>Certificate</li> <li>Tutor group awards</li> </ul>
<b>Year 8</b> All students	<ul style="list-style-type: none"> <li>Autumn 1: Python Intro (3 hours)</li> <li>Autumn 2: HTML/CSS Intro (2 hours)</li> <li>Spring 1: Web Dev Intro (2 hours)</li> <li>Spring 2: Python 1 (First 4 hours)</li> <li>Summer 1: Javascript Intro (3 hours)</li> </ul>	<ul style="list-style-type: none"> <li>CA Badge</li> <li>Certificate</li> <li>Tutor group awards</li> </ul>



# SEA CADETS

FOR YEARS:  
KS3

 **SEA  
CADETS**

Part of the Sea Cadets family, Royal Marines Cadets enjoy all the exciting activities on water that Sea Cadets do, as well as branching off into serious adventure training too. Specialising in orienteering, field craft, and weapons handling makes Royal Marines Cadets unique, and you can join from the age of 13 to 18.



# NATIONAL SATURDAY CLUB

FOR YEARS:  
ALL

At the UAL Saturday Club we will be covering an array of different Art, Design, Textile and Photography skilled based workshops.

Throughout the year our Saturday Club's aim and focus is to support and nurture our Club members creative ideas in a fun and exciting space. We will have workshops that encourage young people to collaborate, make new friends and explore their creative ideas.

During the Saturday Club year, at UAL, Lime Grove, club members will learn new skills and techniques in Creative Photography, Painting, Drawing, Printmaking, Garment Generation, Comic Book Storyboarding and Magazine Design with the help of UAL's tutors and industry professionals.

Members work will be exhibited at Somerset House!

## University of Arts



# CAREERS ENTERPRISE COMPANY

FOR YEARS:  
ALL

The Sixth Formers' Guide to Degree Apprenticeships is the new A-Z guide to degree apprenticeship employers in the UK. Produced in partnership with The Careers & Enterprise Company and the Department for Education, the guide explains how degree apprenticeships offer a work-led, debt-free route to a university degree and a graduate job.

The Careers & Enterprise Company

## **The Sixth Formers' Guide** **Degree Apprenticeships**

Over **3,500 degree apprenticeships** available for students leaving school or sixth form college in the **summer of 2026.**





# Science, Technology, Engineering, Mathematics and Medicine

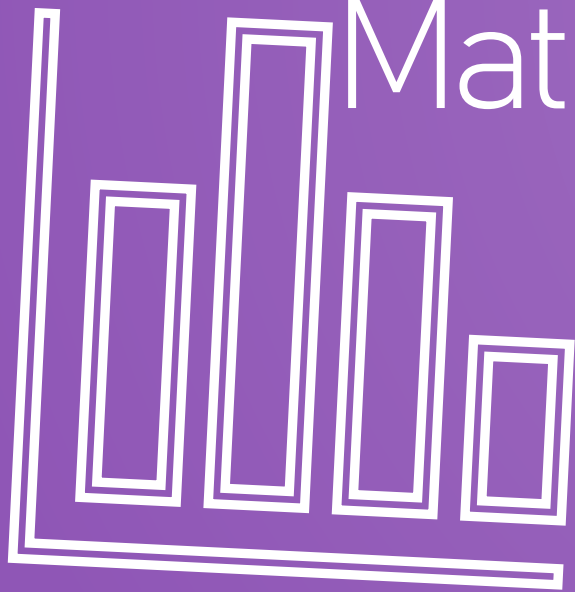

*'I have come that you should have life and life in all its fullness'*



# VIRTUAL WORK EXPERIENCE: DENTISTRY

FOR YEARS:  
Y10–Y13

Virtual work experience is now recognised by the Medical Schools and Dental Schools Council as a valuable alternative to in-person shadowing. This is supported by the Health Education England Discovery report, which highlights the positive impact of virtual placements.

Not only is this a reliable alternative to in-person shadowing, but it also plays a significant role in preparing students for their in-person work placements with structured teaching and opportunities to speak directly with healthcare professionals.

## Medic Mentor

MEDIC  
MENTOR   
YOUR MEDIC FAMILY



# VIRTUAL WORK EXPERIENCE: MEDICINE

FOR YEARS:  
Y10–Y13

*Virtual work experience is now recognised by the Medical Schools and Dental Schools Council as a valuable alternative to in-person shadowing. This is supported by the Health Education England Discovery report, which highlights the positive impact of virtual placements.*

*Not only is this a reliable alternative to in-person shadowing, but it also plays a significant role in preparing students for their in-person work placements with structured teaching and opportunities to speak directly with healthcare professionals.*

## Medic Mentor

MEDIC  
MENTOR   
YOUR MEDIC FAMILY



# EDUCATIONAL DEVELOPMENT COURSES - STEM

FOR YEARS:  
Y11-Y13

Leaf is a highly selective online program that prepares talented teenagers to make a positive impact at university and in their future careers. Our January–February cohort will bring together exceptional 15–19-year-olds to explore how they can apply their academic talents to solving global challenges and prepare for meaningful study at top universities.

Students can choose from:

- The Mathematics of Morality — how quantitative reasoning can shape ethical decisions
- Dilemmas and Dangers in AI — steering powerful technology toward good
- Biology for a Better Tomorrow — science in service of human flourishing and the natural world
- History to Shape History — lessons from economics, law, and the past to guide humanity's future

Leaf

**Leaf**  
**Explore Tomorrow**



# DIGITAL RETAILS

FOR YEARS:  
Y10-Y13

Are you curious about where a career in retail can take you - from the shop floor to the boardroom?

Have you thought about how AI, Cyber Security and Sustainability play a role in the shops where we buy our groceries?

Join Tata Consultancy Services (TCS) for Retail Reimagined, a unique and inspiring virtual event designed to spotlight the exciting range of careers in the grocery retail sector.

## TATA Consultancy

**tcs** **TATA**  
**CONSULTANCY**  
**SERVICES**



# STEM/MARKETING

FOR YEARS:  
KS5 SF (12-13)

## Futures For All

Go behind the scenes to see how we develop brand new chocolate products in the heart of Bournville, Birmingham. Learn from Product Developers how we produce new product ideas.

If you could create a product, what would it be? Gather data with the Consumer Scientists to learn if consumers like your product. Think about how your product will be made and the role of Process Engineers & Packaging Designers in this.

To find out more and register, click the link below.



# WOMEN IN LEADERSHIP AND TECH

FOR YEARS:  
Y10-Y13

*Are you a female sixth form student looking to explore career paths and gain real insights into the tech world?*

*Oracle is the 3rd largest software company in the world with over 160,000 employees across 75 different countries. This unique experience is tailored to help you explore your future career options in a Global Tech Corporation. Whether you've thought about it before, or are just curious about a career in STEM, join us for an insightful 3-day workshop.*

*This programme is run by Oracle Women in Leadership, designed to focus on helping young women in sixth form to navigate their career options.*

## Oracle



# OXFORD SPARKS PODCASTS

FOR YEARS:  
ALL

OXFORD  
SPARKS

Oxford Sparks has podcasts and videos that are similar to lectures. You can learn new things or develop your existing knowledge of your interests.

Additionally, there is access to scientists and researchers in selected fields, which you can contact through email or follow on social media to access any information given out by them.

**SCIENCE IS ...**

**INNOVATING TECHNIQUES TO**

**SAVE ENDANGERED**

**SPECIES**

**SCIENCE IS ...**

**LOOKING FOR ANSWERS**

**DOWN THE MICROSCOPE**





# Social Sciences (Humanities, Finance & Languages)



*'I have come that you should have life and life in all its fullness'*



# ACCOUNTING

FOR YEARS:  
Y12-Y13

## National Audit Office

Thinking about an apprenticeship in accountancy?

Join our free, live webinar and hear first-hand from NAO apprentices about what it's really like to learn, earn and make an impact. Bring your questions - they're ready to answer them all!

The National Audit Office (NAO) is the UK's independent public spending watchdog. They scrutinise public spending for Parliament and hold government to account for how public money is spent - shaping decisions that impact healthcare, education and more.

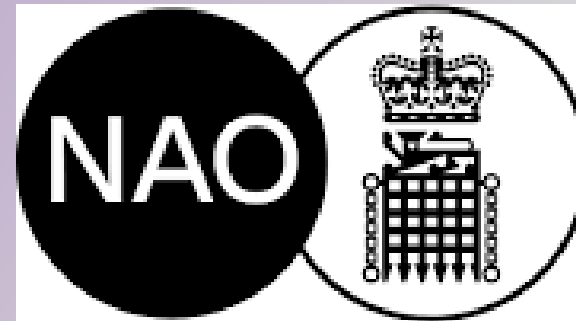

## National Audit Office



# ACCOUNTING

FOR YEARS:  
Y12-Y13

BDO

Accounting isn't what you think it is... Over two weeks, you'll gain an introduction to the world of audit, tax, and advisory, learn more about BDO, and discover what makes careers in accounting beyond the ordinary!

Informative online modules and interactive quizzes help you make informed career decisions, learn useful skills, and explore your career opportunities. And when you're done, you'll receive a personalised certificate and further engagement and learning opportunities. You can start driving your career at any time – our virtual work experience programme is available to students from 13 years old.

**WORK EXPERIENCE &  
INSIGHT DAYS**



# FINANCE

FOR YEARS:  
ALL STUDENTS

Are you ready to secure a top-tier apprenticeship straight after school?

The competition is fierce. The applications are complex. You need more than just good grades—you need an insider's edge.

Join us for this exclusive, masterclass led by recruitment experts from BNP Paribas, a global leader in banking and finance. This isn't a lecture; it's a practical training session designed to turn your potential into a successful application.

## BNP Paribas

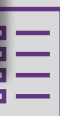

# LAW: WORK EXPERIENCE

FOR YEARS:  
Y10-Y13

Exploring Careers in Law Across Industries  
3rd – 5th March 2026

Application Deadline: 10th February 2026

Open to Years 10 – 13 students

Do you dream of a career in sports, retail fashion, or environmental law? While not everyone becomes a star athlete, designer, or environmental activist, law plays a key role behind the scenes—protecting teams, brands, events, and the planet.

Join our 3-day online placement and discover how legal skills shape the industries you care about. Work on real-world challenges, explore careers, and develop skills that will boost your future.



## DWF Law LLP



# LAW: WORK EXPERIENCE

FOR YEARS:  
Y12

Every year, we invite applications from students in Year 12 from lower socioeconomic backgrounds to participate in one of two work experience programs.

Find out more about these programs, who's eligible, and how to apply below.

## A&O Shearman



# LAW: WORK EXPERIENCE

FOR YEARS:  
Y12

## Clifford Chance

ACCESS is an award-winning, two-year development programme for Year 12 (or equivalent) students. For many years and as a founding member of PRIME we've been challenging the idea that entering the legal profession depends on who you know or what background you're from. Our response is ACCESS, a pioneering programme consisting of different components focused on developing your understanding of what a career in law involves. The programme is packed with accessible content, real legal sector insights, and opportunities to develop your key skills, confidence, and commercial awareness. The programme consists of paid and unpaid elements, with carefully considered financial support.



# LAW: WORK EXPERIENCE





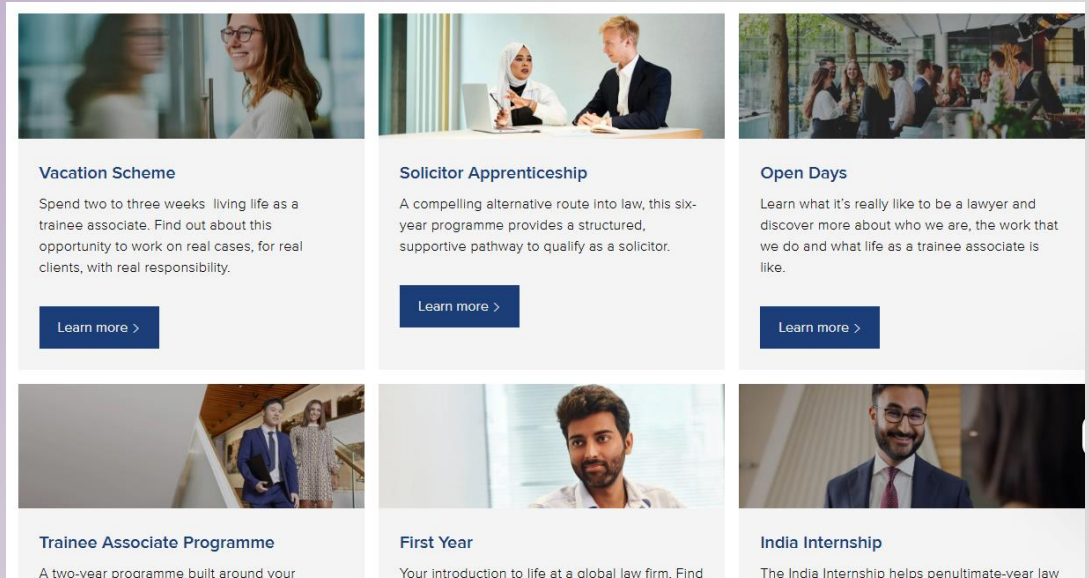

FOR YEARS:  
Y12

## Herbert Smith Freehills Kramer

Where could a career in law take you? Whether you're ready to apply or just starting to explore, our programmes and events are designed to help you learn, grow and make confident choices — wherever you're starting from.

From insight schemes to international internships, you'll discover what it's like to do meaningful work at a global firm — and how your ambition can shape your journey here.



 <p><b>Vacation Scheme</b></p> <p>Spend two to three weeks living life as a trainee associate. Find out about this opportunity to work on real cases, for real clients, with real responsibility.</p> <p><a href="#">Learn more &gt;</a></p>	 <p><b>Solicitor Apprenticeship</b></p> <p>A compelling alternative route into law, this six-year programme provides a structured, supportive pathway to qualify as a solicitor.</p> <p><a href="#">Learn more &gt;</a></p>	 <p><b>Open Days</b></p> <p>Learn what it's really like to be a lawyer and discover more about who we are, the work that we do and what life as a trainee associate is like.</p> <p><a href="#">Learn more &gt;</a></p>
 <p><b>Trainee Associate Programme</b></p> <p>A two-year programme built around your</p>	 <p><b>First Year</b></p> <p>Your introduction to life at a global law firm. Find</p>	 <p><b>India Internship</b></p> <p>The India Internship helps penultimate-year law</p>



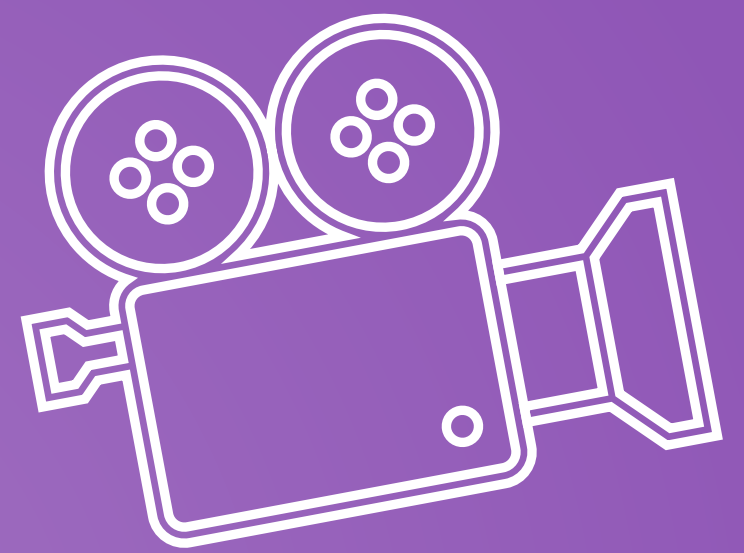
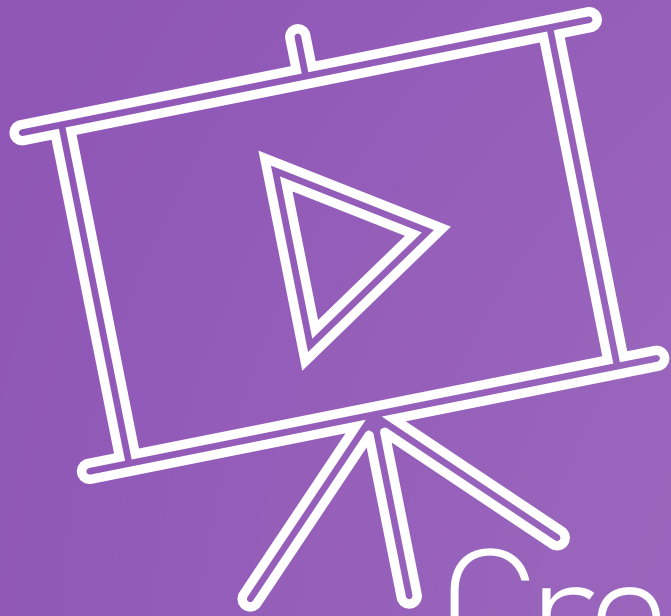

# Creative Arts (Fashion/ Media/Productions)

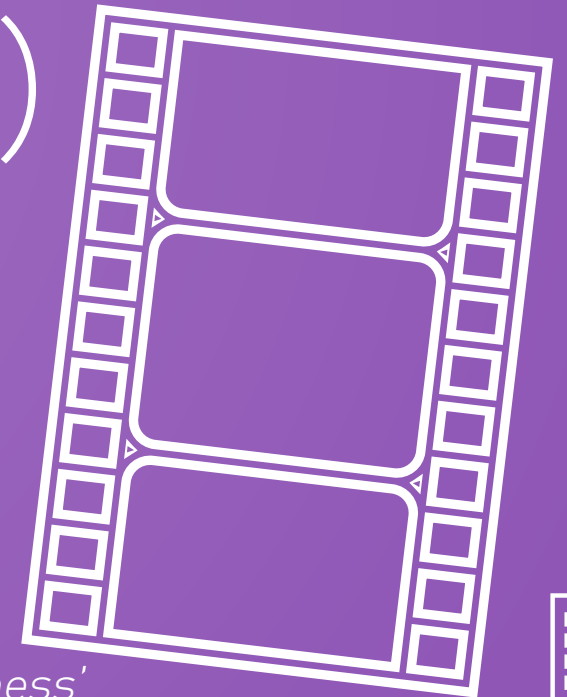

*'I have come that you should have life and life in all its fullness'*



# WORK EXPERIENCE: CHANNEL 4

FOR YEARS:  
Y10-Y13

Discover the exciting world of creative careers in TV and Broadcasting. Gain unique insights into what it takes to build a successful national broadcaster like Channel 4.

This experience will open your eyes to a variety of roles across the industry and provide meaningful work experience, from technical positions to on-camera roles, and introduce you to the talented people who make it all happen. With over 4,200 participants in the UK already gaining valuable industry knowledge, it's your turn to dive in. Ready to explore and build your creative career?

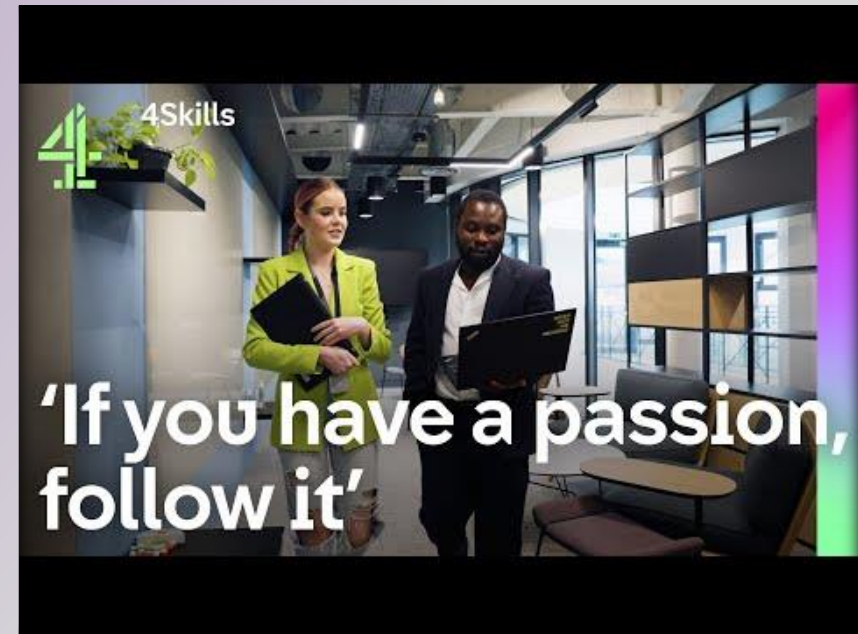

# FASHION HISTORY PODCAST

FOR YEARS:  
ALL

“With over 8 billion people in the world, we all have one thing in common. Every day we all get dressed. Join Dressed as we explore the social and cultural histories behind the who, what, when of why we wear.”

This week, Dr. Kate Annett-Hitchcock joins us for a two-part episode to speak about her recently released book, *The Intersection of Fashion and Disability: A Historical Analysis*, which spans over 500 years of dressing for disability.



Apple Podcasts

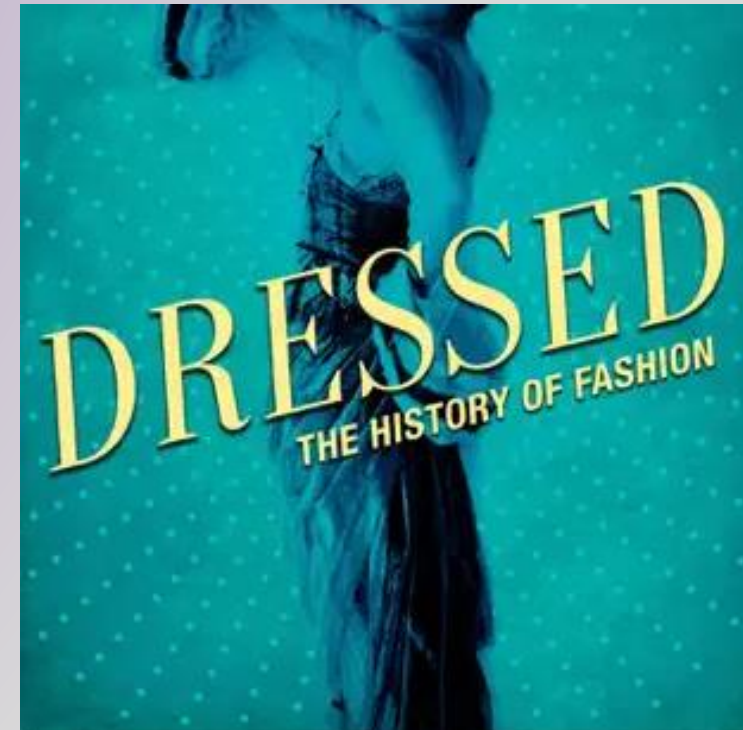

# CREATIVE

FOR YEARS:  
KS5



What's your favourite building and why ?

What lessons can we learn from your chosen building ?

How will you share your choice with us ?

Submit an essay, poem, film, artwork or photography for your chance to be published in a physical book, showcased online and exhibited at a special celebration ceremony held in London.



# THEATRE ART LIFE

FOR YEARS:  
ALL

# TheatreArtLife.

Theatre Art Life presents many easily accessible podcasts, articles, and resources that can be useful in widening your general knowledge about art and acting.

This is, of course, useful for all sorts of applications, cover letters, and personal statements.

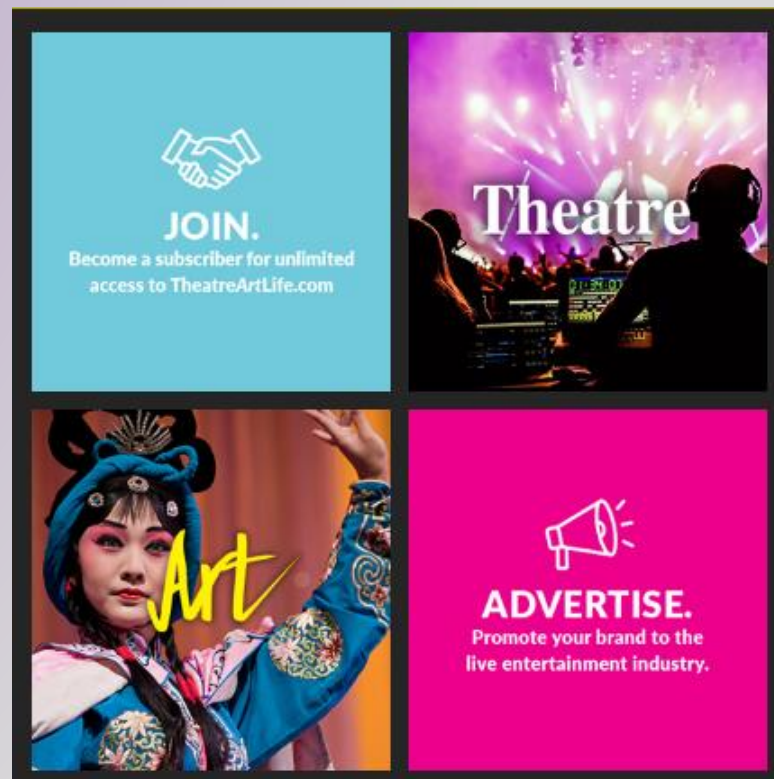

# ANIMATION, GAMES, AND VISUAL EFFECTS

FOR YEARS:  
KS5

Did you know the creative industries are the UK's fastest growing sector? Estimated to grow by 26% this year, contributing £132.1 billion to the UK economy (Gov UK), now's the time to start thinking about your creative future.

Get your foot in the door with a world leading creative school. At Escape Studios, we're ranked 1st in the world for Production Excellence in Immersive Media by The Rookies, accredited as a Toon Boom Harmony and Unreal Engine Authorised Training Centre.

**ESCAPE**  
STUDIOS



# THE UNSEEN DRAMA SCHOOL

FOR YEARS:  
10-13

Experience cutting-edge acting courses taught by highly respected teachers from top UK Drama Schools alongside specialised Unseen tutors, incorporating renowned techniques like Meisner, Stanislavski and Chekhov.

With a thriving management pillar and proven track record in developing accomplished actors, our monthly showcases are watched by some of the world's leading casting directors and agents, and we hold live events at prestigious venues such as Soho House and Electric Cinema in London.

## THE UNSEEN

Acting school & Talent Management **DRAMA**

**LIGHT COURSE OPTION**  
**SUMMER SPECIAL £199**

Training sessions will be held for 20 hours over a span of 4 weeks at our studio in central London.  
Bookings are open until October 30, 2024.

UNSEEN  
AMBASSADOR  
**ROBERT  
SHEEHAN**  
(UMBRELLA ACADEMY)



# ST MARY'S UNIVERSITY

FOR YEARS:  
KS5 SF (12, 13)

The St Mary's Schools and Colleges team, in collaboration with academic departments, is delighted to offer a wide range of Masterclass Days to learners considering or having applied to university.

Each offered event includes workshops specific to that subject area, allowing learners to experience seminars, lectures, and sessions at the university level.



St Mary's  
University  
Twickenham  
London

21 January 2026

**CMS Research Seminar:  
Marian iconography in the  
context of Portuguese  
Confraternities of Mercy**

Research

11 February 2026

**The Centre for Marian Studies  
research seminar: "Sweet  
Mother and Militant Virgin: The  
Two Faces of Mary"**

12 March 2026

**British Science Week Fair**

Schools and Colleges

Conferences

12 March 2026

**St Mary's University  
Postgraduate Open Evening**

Open Days

21 March 2026

**Undergraduate Offer Holder  
Day**

Open Days

16 April 2026

**St Mary's University PGCE  
Teacher Training Open  
Evening**

Open Days

18 April 2026

**Undergraduate Offer Holder  
Day**

Open Days

5 June 2026

**St Mary's University  
Postgraduate Open Afternoon**

Open Days

2 July 2026

**St Mary's University London,  
Teacher and Adviser  
Conference**

Conferences

Schools and Colleges



# TEXTILES SKILLS CENTRE

FOR YEARS:  
KS5 SF (12-13)

TEXTILES  
SKILLS CENTRE

This website shows lots of events and talks that are being hosted in the textile career sector. The 'Tea N Chats' are delivered by textile artists, teachers and industry professionals and are completely free of charge and run by groups of volunteers for anyone to attend, pending registration for each event.

This is a fantastic resource for fashion and creative-minded students.



# V&A EVENTS

FOR YEARS:  
ALL

The V&A has many different events and exhibits taking place at its venue, which can help students grasp information about the respective event. Some are free, but some are fee-based.

These can be good for Sixth Former's CASE hours and for students who are looking to study fashion or art.

Find out more from the link below





# V&A



Exhibition

## Jameel Prize: Moving Images

 Opens Saturday, 30 November 2024

 V&A South Kensington



Display

## Lucian Freud's Etchings: A Creative Collaboration

 Closes Sunday, 5 January 2025

 V&A South Kensington



# GOOGLE'S DIGITAL MARKETING COURSE

FOR YEARS:  
KS5 SF (12, 13)

# Google

Master the basics of digital marketing with our free course accredited by Interactive Advertising Bureau Europe and The Open University. There are 26 modules to explore, all created by Google trainers and packed full of practical exercises and real-world examples to help you turn knowledge into action.

For more information, see the link below.



The multi-colored Google logo.



## Free Digital Marketing Course

Learn Digital Marketing with Free Certificate from Google Digital Garage



# SCREENSKILLS' MODULES IN MEDIA

FOR YEARS:  
KS5 SF (12, 13)

The logo for ScreenSkills, featuring a stylized graphic of horizontal lines above the text "ScreenSkills".

## Getting into the screen industries

This suite of five e-learning modules from ScreenSkills is designed to help people get their first break in the screen industry.

It starts with an introduction to the screen industry and the various roles involved.

The remaining modules will help you identify the right role for your skills, how to find work, how to apply for a role and how to perform well at an interview.

For more information, see the link below.





# Public Service & Volunteering



*'I have come that you should have life and life in all its fullness'*



# EALING WILDLIFE GROUP

FOR YEARS:  
11-13



Volunteering with Ealing Wildlife Group offers an amazing experience. They have the opportunity to work with other like-minded individuals, to collaborate on and foster thriving and healthy wildlife habitats, enhancing the well-being of the people involved.

We have opportunities across all our projects and within our central team of officers, ranging from hands-on tasks like habitat maintenance and working on one of our conservation projects to helping with social media or community outreach



# KPMG SKILLS BUILDER

FOR YEARS:  
Y11-13

Are you a Year 11, 12, 13 student interested in gaining work experience with one of the world's leading professional services firms?

Join the KPMG Virtual Work Experience Day during the Easter Break to explore career opportunities in business, finance, accounting, and professional services while developing key employability skills.

## Event Details

Date: Monday, 14th April

Time: 10:00 AM – 3:00 PM

Location: Virtual (join from anywhere)

Who Can Attend? Year 11, 12 and 13 students



# VIRTUAL VOLUNTEERING

FOR YEARS:  
ALL YEARS

IGD

The companies that take part in our employability programmes represent the breadth and diversity of our industry and include the big household names of the food retailers on our highstreets, and manufacturers of the iconic brands that sit in our cupboards. We are the largest programme of its type in the country and is truly unique because it involves so many companies!

The food and consumer goods industry is the UK's largest private sector employer, employing one in seven people. IGD is uniquely placed to bring together industry professionals to help young people build confidence and the employability skills needed for a fulfilling career in the industry.

Together we help thousands of young people develop their employability skills and support our industry to develop a pipeline of talent. Find out below how you can take part.



# VIRTUAL VOLUNTEERING

FOR YEARS:  
Y10-Y13

We're pleased to announce that both of our summer work experience schemes at Brentford FC Community Sports Trust are now open to applicants. Please do have a look over the below information and attached flyer and share with your students.

Both cohorts are open to young people from year 10 through to 13, most suitable for young people in neighbouring boroughs (TW, UB, W, NW, and KT - Kingston or Richmond).

## Brentford Community Sports Trust



# NHS HEALTHCARE CAREERS

FOR YEARS:  
10-13

**NHS**

The NHS Virtual Allied Healthcare Work Experience offers a unique opportunity for aspiring healthcare professionals. It's a rare occasion for students to hear from our exceptional guest speaker, Simon Otter, a Podiatrist specialising in the diagnosis, treatment, and management of conditions and injuries affecting the foot, ankle, and lower leg.

Simon will provide invaluable guidance to help these future professionals embark on their dream healthcare careers. Following Simons talk, students will gain an intimate look at the healthcare industry in the LIVE virtual work experience, delving into diverse roles within allied healthcare and taking a closer look at patient care by following the journeys of two patients from incident through to treatment.



ALLIED  
HEALTHCARE  
MENTOR





# Apprenticeships

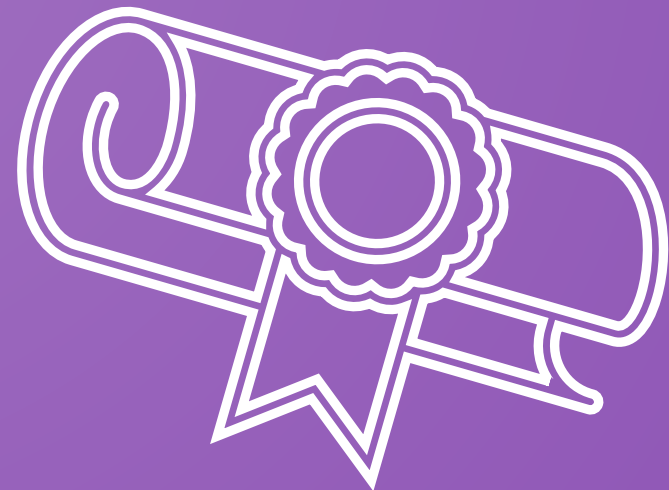
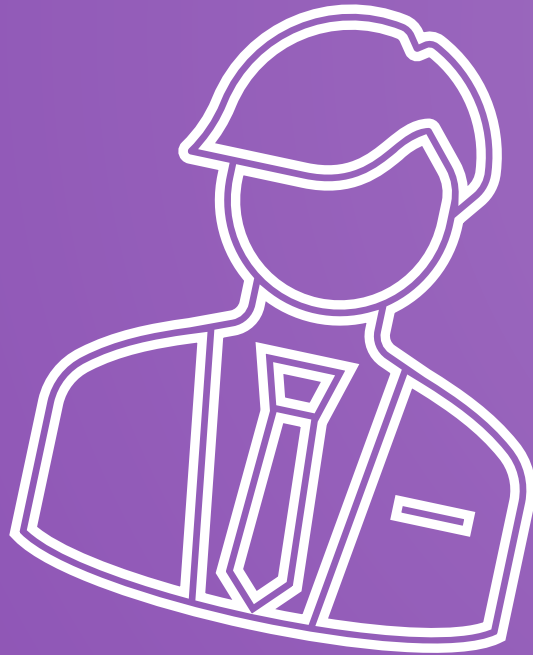

*'I have come that you should have life and life in all its fullness'*



# HMGCC

FOR YEARS:  
Y13

His Majesty's Government  
Communications Centre

We offer fully funded government apprenticeships, with different entry levels depending on the programme.

To earn a place as an HMGCC apprentice, you'll need to meet the entry requirements listed for the relevant apprenticeship, have bags of enthusiasm and a genuine interest in software, technology or engineering.



# LLOYDS BANKING APPRENTICESHIPS

FOR YEARS:  
KS5

Lloyds

Think finance isn't for you? Think again. We're the UK's biggest digital bank, trusted by 28m+ customers every single day. From cracking code to crunching data, from finance to green ideas, this is where you get to change up the status quo. We put £3bn a year into new tech, fresh thinking and big transformations. So, yep, it's not all spreadsheets and sums.

A place where you can be you

Come as you are and stay as you grow. We think best ideas come from mixing it up - backgrounds, perspectives, voices. That's why you'll find communities here like REACH (Black, Asian and minority ethnic colleagues), Rainbow (LGBT+), Breakthrough (women) and enable (disability). Whoever you are, whatever makes you tick, you'll fit right in.

Grow faster. Aim higher. We'll back you all the way



# AUTOMOTIVE APPRENTICESHIPS

FOR YEARS:  
KS5

## VOLKSWAGEN

AKTIENGESELLSCHAFT

Working within our trusted retail network, you will experience hands-on learning while being mentored by industry experts. You will train at our world class training facility in Milton Keynes, working with the very latest automotive technology and amazing vehicles.

Volkswagen Group is paving the way for the biggest change process in its history: the realignment of one of the best carmakers to become a globally leading provider of sustainable mobility.

We are looking for next generation of amazing people to join our team and help us to achieve our transformation within the automotive industry. Achieve more with a Volkswagen Group apprenticeship

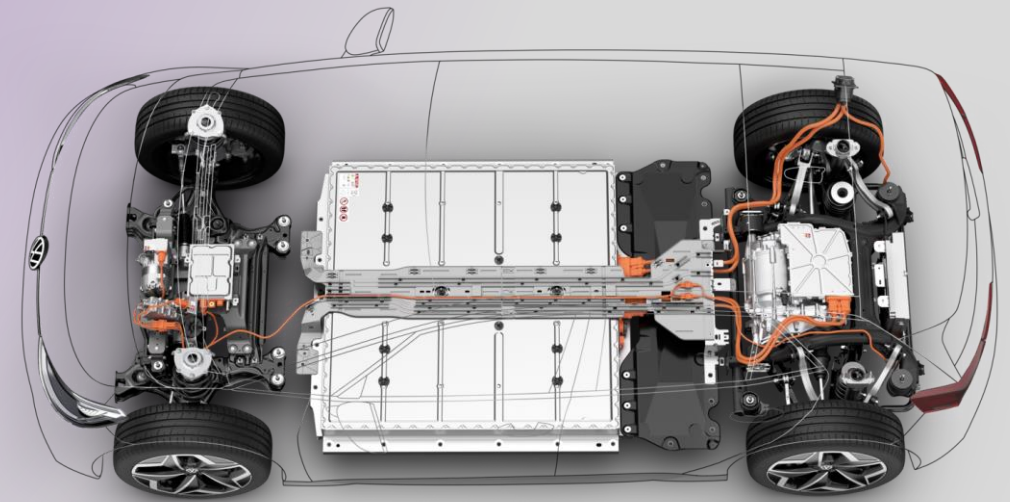

# AUTOMOTIVE APPRENTICESHIPS

FOR YEARS:  
KS5



Your apprenticeship will just be the start. Many of our learners continue their careers with us post-apprenticeship and are encouraged to continue their development via a structured learner journey within their chosen field.

All of our opportunities receive a good response and so we're looking for you to demonstrate why you stand out from the crowd. We're not looking for the finished article; rather we want to identify those people that are ambitious and demonstrate a willingness to learn, who are excited by the prospect of working with our fantastic, technologically advanced vehicles and really engage in the

**UNBEATABLE OPPORTUNITIES**  
**UNRIVALLED EXPERIENCE**  
**UNIQUE JOURNEYS**

**IT ALL BEGINS WITH U**

Volvo Truck & Bus Apprenticeship Programme



# NETWORK RAIL

FOR YEARS:  
LEAVERS (11, 13)



Are you ready to embark on an exciting journey towards a fulfilling and rewarding career in the world of railways? Look no further than Network Rail! Your gateway to a world of possibilities, innovation, and endless opportunities. Join us as we explore the exciting world of Network Rail and discover how they can kickstart your career on the right track!

Whether you're looking for an apprenticeship, undergraduate programme or graduate scheme, Network Rail has a whole range of opportunities and you might be surprised to hear that these range from engineering to IT & Business management, plus everything in between!



# APPRENTICESHIPS FAIRS

FOR YEARS:  
LEAVERS (11, 13)

2026 London UK University & Apprenticeship Search Fairs. The events will take place at Arsenal FC's spectacular Emirates Stadium on Thursday 26th March

The London fairs will feature:

- A multitude of exhibitors including: Russell Group, red brick, modern institutions and apprenticeship providers.
- Vital seminars by university and industry experts, including key topics: UCAS Personal Statement, Degree Apprenticeships, Student Finance and Why take an Apprenticeship.
- Interactive demonstrations
- Student and teacher catering areas
- Digital brochure with university and apprenticeship help and advice
- Our Brunel University of London event also features campus tours and free coach parking



UK UNIVERSITY & APPRENTICESHIP SEARCH FAIR

UK university & apprenticeship search fairs

26th March 2026

London

9.30am - 2.30pm

100+ Exhibitors

Special Focus:

- UCAS Applications
- Applying for Apprenticeships

London, Arsenal FC Emirates Stadium, N7 7AG

The poster features a vibrant background with overlapping circles in shades of blue, purple, and orange. On the right, a photograph shows a man in a blue striped shirt talking to a group of young women at a table covered with brochures. A circular inset at the bottom left shows the exterior of the Emirates Stadium.



# JAGUAR LAND ROVER RETAIL APPRENTICESHIPS

FOR YEARS:  
KS5 SF (12-13)

JLR

Jaguar Land Rover is a company that combines two much-loved, highly prestigious British car brands. We seek people who share our passion to join our highly successful Retail Apprenticeship Programme.

The network stretches across the UK and offers a variety of exciting and challenging apprenticeship opportunities that support our people in reaching their full potential.

Jaguar Land Rover has ambitious growth plans and recognises the importance of identifying talented people to become the next generation of professional retailer employees.



# FORVIS MAZARS

FOR YEARS:  
KS5 SF (12-13)

**forvis**  
**mazars**

Passionate about making a difference? Work with **charities, social enterprises, and non-profits**, helping them maintain financial transparency and accountability. A great option for those who want a **rewarding career with social impact**.

Forvis Mazars LLP is the UK firm of Forvis Mazars Group. In the UK we have over 3,300 employees across 14 locations, delivering an outstanding client experience. Forvis Mazars is an engine for rapid and consistent career progression, offering career paths that help you pursue your interests, match your changing needs, and explore your true potential. We work with diverse, prestigious clients across a range of sectors and geographies, giving you the opportunity to constantly update and grow your skills for lifelong professional development.



# AMAZON APPRENTICESHIPS

FOR YEARS:  
LEAVERS (11, 13)

amazon

Amazon offers some Level 3 (A-Level equivalent) and Level 4 (equivalent to the first year of an undergraduate degree) apprenticeships.

They offer a range of jobs from Stock Management to Engineering, limited by the availability of positions.

To have a look at what apprenticeships are currently available, click the link below.



# KPMG'S 2025 APPRENTICESHIPS

FOR YEARS:  
LEAVERS (11, 13)

Uncover a world of career opportunities and join us in auditing, consulting, KPMG business services, technology, or tax at KPMG.

You'll receive training, qualifications – including degrees – and work experience that will give you the opportunity to grow and develop all while earning a salary. Our inclusive KPMG community will support you to be at your best, as you experience a rewarding career – with a competitive salary and a broad range of employee benefits too.

# KPMG



APPLY  
HERE



MORE  
INFORMATION



# ACCOUNTANCY APPRENTICESHIPS

FOR YEARS:  
LEAVERS (11, 13)

aat

For young people who want to build practical skills and make their mark, studying an AAT qualification could be a great alternative to university. They'll gain the practical skills employers need and kickstart their career as an accountant, a business owner, or any role needing strong finance skills.

AAT is a world-leading professional body. We provide internationally-recognised accounting and bookkeeping qualifications, which are highly practical and in demand with employers. We help 80,000 people take charge of their careers each year, and we support nearly 137,000 members around the world.



ICS Learn | aat Approved

**How to Choose the Best Accountancy Qualification for You**

[Read Now](#)

Accountancy





# Information, Resources & Open Days



*'I have come that you should have life and life in all its fullness'*



# UCAS' UPDATE TO PERSONAL STATEMENTS

FOR YEARS:  
12

## UCAS

UCAS has announced that the Personal Statements will be changed from 2026 Admissions.

These changes mean that students will no longer write a 4000-character long statement but instead will be tri-sectioned, each with a minimum word count of 350 characters and with questions to aid students.

Click the links for more information and the resources UCAS offers to help students.



MORE  
INFORMATION



UCAS  
RESOURCES



# SOCIAL MOBILITY FOUNDATION'S ASPIRING PROFESSIONALS PROGRAMME

FOR YEARS:  
12

SOCIAL  
MOBILITY  
FOUNDATION

Social Mobility Foundation has opened its Aspiring Professional Programme. The programme gives students the skills, guidance, confidence and networks to access and thrive in higher education and top careers.

They provide:

- Mentoring with a professional via email
- Tailored skills sessions and career workshops
- University application support and guidance
- Internships with top employers
- Social impact career advice

To find out more, click the link below.



# CLICK CAMBRIDGE 2025

FOR YEARS:  
12

## ClickCambridge 2025

ClickCambridge is an exciting outreach programme to support Bangladeshi, Pakistani, and Arab (BPA)/mixed-BPA students to prepare for Sixth Form and university-level study. The programme is completely free of charge.

The programme will begin with interactive webinars between January and March 2025. Topics include making post-16 subject choices, studying skills, and preparing for university. Sessions will feature insights from current BPA Cambridge students. Students can also apply to attend a one-night residential at the University of Cambridge in August 2025. The residential is completely free of charge, including travel, accommodation, food, and all activities.

Deadline: 10th January.



# UCAS' OPEN DAY PAGE

FOR YEAR GROUPS:  
KS5 SF (12-13)

# UCAS

UCAS has a page where you can see the open days for different courses or a general open day for different UK universities. Looking at these other universities can significantly impact where you might choose to study and whether you choose to go or not to go to a university for further education. The site also shows virtual tours for many UK universities (some don't yet have this feature available).

To view this page, click on the link below.



**Search for an open day**



**Virtual tours**



**All about open days**



# MICROSOFT STUDENT HUB

FOR YEARS:  
12



Microsoft Student Hub has free resources for students, including:

- Competitions to build experience and confidence
- A GitHub CoPilot course where you learn about AI with the help of an AI assistant
- Free cloud credit
- Free courses such as Foundational C#
- Free developer tools
- Free Communities

For more information, click on the link below.





# CIAG Team



*Careers, Information, Advice and Guidance Student & Staff Teams, & Contact Info*

*'I have come that you should have life and life in all its fullness'*



# OUR CIAG TEAM

Mr J. Chugg | CIAG Lead | [jchugg@williamperkin.org.uk](mailto:jchugg@williamperkin.org.uk) *(please use CIAG emails first)*

[enquiries@WPNCIAG.onmicrosoft.com](mailto:enquiries@WPNCIAG.onmicrosoft.com) - *Questions or Help for Students/Parents about the newsletter*  
[CareersIAG@williamperkin.org.uk](mailto:CareersIAG@williamperkin.org.uk) - *CIAG General Email*

If you know of any opportunities that can be promoted to students or added to the newsletter, please email us:  
[submissions@WPNCIAG.onmicrosoft.com](mailto:submissions@WPNCIAG.onmicrosoft.com)

